

GÜHRING

- High-performance machining
- higher cutting speeds
- outstanding tool life
- universal application in a wide variety of materials



Pionex THE NEW GENERATION *THREADING TOOLS*

GÜHRING – YOUR WORLDWIDE PARTNER

Pionex

THE NEW GENERATION **THREADING TOOLS**

Due to a homogeneous cutting edge an **outstanding and excellent coating adhesion** can be realised.

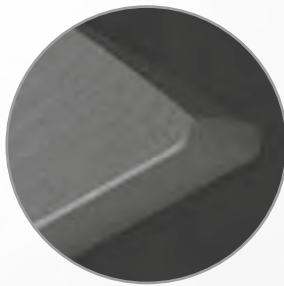

Tapered thread for **perfect chip evacuation.**

An enhanced coating system based on hard material glide coating ensures **lower friction, an improved chip evacuation and a higher tool life.**

A

S

The unique material-mix of the Sirius-coating of the mechanically tough-hard TiAlN and chemically extremely stable zirconium nitride **guarantees a high wear protection and a better chip evacuation.**

PionexTAP



- higher cutting rates
- longer tool lives
- fewer tool changes
- reduction of number of tools in operation

PionexFlutelessTAP

A special surface finish treatment in combination with the TiCN-coating ensures **increased wear-resistance**.

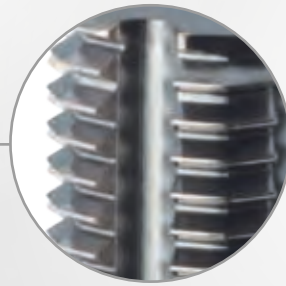

Based to the modified polygon form the contact surface between tool and functionality area could be optimised. **This reduced torque by up to 30%.**

Increased wear-resistance thanks to the application of a new powder metallurgical base material.

Due to the shank tolerance h6 the new fluteless tap generation can be applied in all standard clamping chucks.

New lubricating groove geometry

Thanks to the optimised lubricating grooves the **lubricating effect has been clearly improved in the forming lead area.**









ISO code

P	Steel, high-alloyed steel
M	Stainless steel
K	Grey cast iron, spher, graphite/mall. cast iron
N	Aluminium and other non-ferrous metals
S	Special, super and titanium alloys
H	Hardened steel and chilled cast iron

On the following price and programme pages you will find for every tool recommendations regarding suitability for the application groups and details of max. tensile strength and hardness:

- optimal suitability
- limited suitability

Pictograms

Tool material	HSS-E		HSS-E-PM			
	High-speed steel					
Tolerance on Ø	4HX	6HX	6GX	7GX	6H +0,1	2BX
Thread type						
	Through hole		Blind hole		Through hole and blind hole	
Cutting direction						
	right		left			
Internal coolant						
	with IC		without IC			
Form	B	C	E			
Type	N	VA	VA R45			

Coatings

- C** TiCN
- A** TiAlN
- S** Sirius

PionexTAP



Blind hole taps

Metric threads.....	p. 8
Metric fine threads	p. 15
UNC	p. 19
UNF	p. 20
G	p. 21



Through hole taps

Metric threads.....	p. 22
Metric fine threads	p. 28
UNC	p. 30
UNF	p. 31
G	p. 32

PionexFlutelessTAP



Fluteless machine taps

Metric threads.....	p. 35
Metric fine threads	p. 38
UNC	p. 41
UNF	p. 42
G	p. 43

Technical Section	p. 45
--------------------------------	-------

Machine taps for ISO metric threads



P	•
M	•
K	○
N	○
S	○
H	

Tool material	HSS-E			
Tolerance on Ø	6HX	6GX	7GX	6H+0,1
Surface	A	A	A	A
Type	VA R45	VA R45	VA R45	VA R45
Form	C	C	C	C
Internal cooling	☒	☒	☒	☒

DIN 371

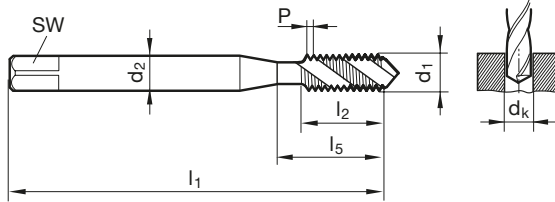

DIN 376

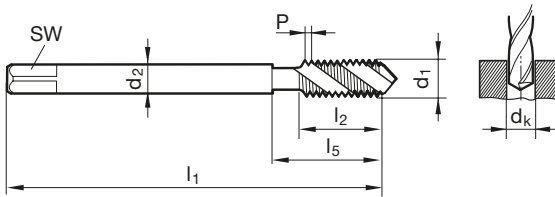

DIN 2184-1 DIN 371/DIN 376

Article no. 393 4625 4626 4627

Discount group 103 103 103 103

d1	P	d2	SW	dk	l1	l2	l5	Code no.	Availability
mm	mm	mm	mm	mm	mm	mm	mm		
M2	0.400	2.800	2.100	1.60	45.000	4.500	13.500	2.000	• • • •
M2,5	0.450	2.800	2.100	2.05	50.000	5.000	14.500	2.500	• • • •
M3	0.500	3.500	2.700	2.50	56.000	6.000	18.000	3.000	• • • •
M3,5	0.600	4.000	3.000	2.90	56.000	7.000	20.000	3.500	• • • •
M4	0.700	4.500	3.400	3.30	63.000	7.500	21.000	4.000	• • • •
M5	0.800	6.000	4.900	4.20	70.000	8.500	25.000	5.000	• • • •
M6	1.000	6.000	4.900	5.00	80.000	11.000	30.000	6.000	• • • •
M8	1.250	8.000	6.200	6.80	90.000	14.000	35.000	8.000	• • • •
M10	1.500	10.000	8.000	8.50	100.000	16.000	39.000	10.000	• • • •
M12	1.750	9.000	7.000	10.20	110.000	18.500	49.000	12.000	• • • •
M14	2.000	11.000	9.000	12.00	110.000	20.000	53.000	14.000	• • • •
M16	2.000	12.000	9.000	14.00	110.000	20.000	54.000	16.000	• • • •
M18	2.500	14.000	11.000	15.50	125.000	25.000	62.000	18.000	• • • •
M20	2.500	16.000	12.000	17.50	140.000	25.000	62.000	20.000	• • • •
M24	3.000	18.000	14.500	21.00	160.000	30.000	73.000	24.000	• • • •
M30	3.500	22.000	18.000	26.50	180.000	35.000	85.000	30.000	• • • •
M33	3.500	25.000	20.000	29.50	180.000	35.000	91.000	33.000	• • • •
M36	4.000	28.000	22.000	32.00	200.000	50.000	102.000	36.000	• • • •
M39	4.000	32.000	24.000	35.00	200.000	50.000	107.000	39.000	• • • •



Machine taps for ISO metric threads



P	•
M	•
K	○
N	○
S	○
H	

Tool material	HSS-E
Tolerance on Ø	6HX
Surface	A
Type	VA R45
Form	E
Internal cooling	

DIN 371

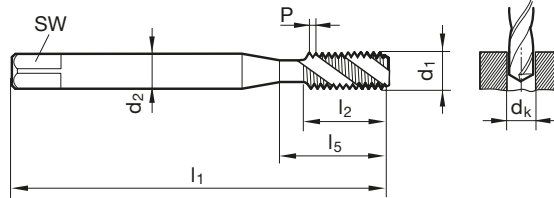

DIN 376

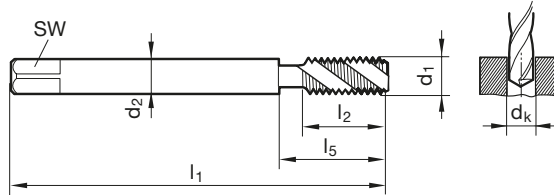

DIN 2184-1 DIN 371/DIN 376

Article no. 4630

Discount group

103

d1	P	d2	SW	dk	l1	l2	l5	Code no.	Availability
mm	mm	mm	mm	mm	mm	mm	mm		
M2	0.400	2.800	2.100	1.60	45.000	4.500	13.500	2.000	•
M2,5	0.450	2.800	2.100	2.05	50.000	5.000	14.500	2.500	•
M3	0.500	3.500	2.700	2.50	56.000	6.000	18.000	3.000	•
M3,5	0.600	4.000	3.000	2.90	56.000	7.000	20.000	3.500	•
M4	0.700	4.500	3.400	3.30	63.000	7.500	21.000	4.000	•
M5	0.800	6.000	4.900	4.20	70.000	8.500	25.000	5.000	•
M6	1.000	6.000	4.900	5.00	80.000	11.000	30.000	6.000	•
M8	1.250	8.000	6.200	6.80	90.000	14.000	35.000	8.000	•
M10	1.500	10.000	8.000	8.50	100.000	16.000	39.000	10.000	•
M12	1.750	9.000	7.000	10.20	110.000	18.500	49.000	12.000	•
M14	2.000	11.000	9.000	12.00	110.000	20.000	53.000	14.000	•
M16	2.000	12.000	9.000	14.00	110.000	20.000	54.000	16.000	•
M18	2.500	14.000	11.000	15.50	125.000	25.000	62.000	18.000	•
M20	2.500	16.000	12.000	17.50	140.000	25.000	62.000	20.000	•
M24	3.000	18.000	14.500	21.00	160.000	30.000	73.000	24.000	•
M30	3.500	22.000	18.000	26.50	180.000	35.000	85.000	30.000	•

Machine taps for ISO metric threads



P	•
M	•
K	○
N	○
S	○
H	

Tool material	HSS-E-PM
Tolerance on Ø	6HX
Surface	A
Type	VA R45
Form	C
Internal cooling	

DIN 371

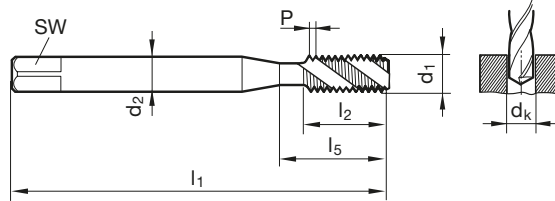

DIN 376

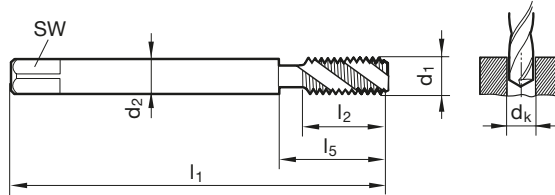

DIN 2184-1 DIN 371/DIN 376

Article no. **4634**

Discount group **103**

d1	P	d2	SW	dk	l1	l2	l5	Code no.	Availability
mm	mm	mm	mm	mm	mm	mm	mm		
M3	0.500	3.500	2.700	2.50	56.000	6.000	18.000	3.000	•
M4	0.700	4.500	3.400	3.30	63.000	7.500	21.000	4.000	•
M5	0.800	6.000	4.900	4.20	70.000	8.500	25.000	5.000	•
M6	1.000	6.000	4.900	5.00	80.000	11.000	30.000	6.000	•
M8	1.250	8.000	6.200	6.80	90.000	14.000	35.000	8.000	•
M10	1.500	10.000	8.000	8.50	100.000	16.000	39.000	10.000	•
M12	1.750	9.000	7.000	10.20	110.000	18.500	49.000	12.000	•
M14	2.000	11.000	9.000	12.00	110.000	20.000	53.000	14.000	•
M16	2.000	12.000	9.000	14.00	110.000	20.000	54.000	16.000	•
M20	2.500	16.000	12.000	17.50	140.000	25.000	62.000	20.000	•



Machine taps for ISO metric threads



P	•
M	•
K	○
N	○
S	○
H	

Tool material	HSS-E-PM
Tolerance on Ø	6HX
Surface	A
Type	VA R45
Form	C
Internal cooling	

DIN 371

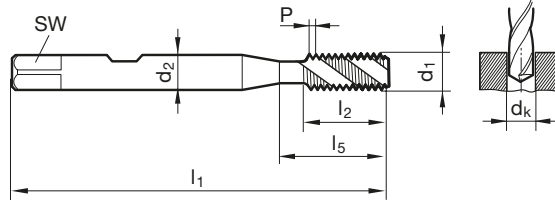

DIN 376

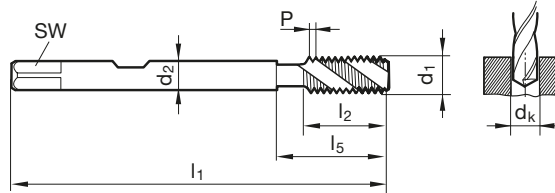

DIN 2184-1 DIN 371/DIN 376

Article no. **4650**

Discount group **103**

d1	P	d2	SW	dk	l1	l2	l5	Code no.	Availability
mm	mm	mm	mm	mm	mm	mm	mm		
M3	0.500	6.000	4.900	2.50	56.000	6.000	18.000	3.000	•
M4	0.700	6.000	4.900	3.30	63.000	7.500	21.000	4.000	•
M5	0.800	6.000	4.900	4.20	70.000	8.500	25.000	5.000	•
M6	1.000	6.000	4.900	5.00	80.000	11.000	30.000	6.000	•
M8	1.250	8.000	6.200	6.80	90.000	14.000	35.000	8.000	•
M10	1.500	10.000	8.000	8.50	100.000	16.000	39.000	10.000	•
M12	1.750	12.000	9.000	10.20	110.000	18.500	49.000	12.000	•
M14	2.000	12.000	9.000	12.00	110.000	20.000	53.000	14.000	•
M16	2.000	12.000	9.000	14.00	110.000	20.000	54.000	16.000	•
M20	2.500	16.000	12.000	17.50	140.000	25.000	62.000	20.000	•

Machine taps for ISO metric threads



P	•
M	•
K	○
N	○
S	○
H	

Tool material	HSS-E
Tolerance on Ø	6HX
Surface	A
Type	VA R45
Form	C
Internal cooling	

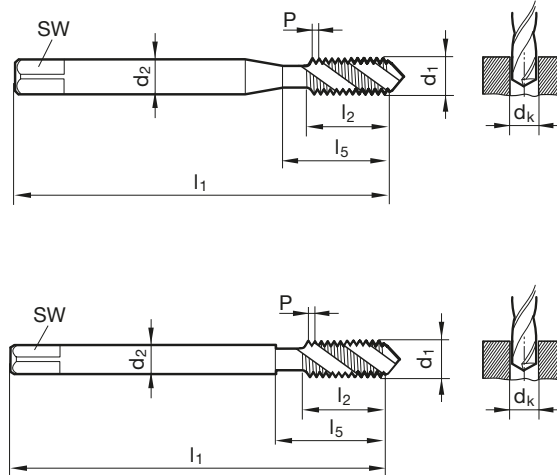

Company std.	Article no.	4633
--------------	-------------	------

Discount group 103

d1	P	d2	SW	dk	l1	l2	l5	Code no.	Availability
mm	mm	mm	mm	mm	mm	mm	mm		
M3	0.500	3.500	2.700	2.50	90.000	6.000	18.000	3.000	•
M4	0.700	4.500	3.400	3.30	125.000	7.500	21.000	4.000	•
M5	0.800	6.000	4.900	4.20	140.000	8.500	25.000	5.000	•
M6	1.000	6.000	4.900	5.00	160.000	11.000	30.000	6.000	•
M8	1.250	8.000	6.200	6.80	180.000	14.000	35.000	8.010	•
M10	1.500	10.000	8.000	8.50	200.000	16.000	39.000	10.010	•
M12	1.750	9.000	7.000	10.20	220.000	18.500	158.000	12.000	•
M14	2.000	11.000	9.000	12.00	220.000	20.000	160.000	14.000	•
M16	2.000	12.000	9.000	14.00	220.000	20.000	160.000	16.000	•
M20	2.500	16.000	12.000	17.50	280.000	25.000	217.000	20.000	•



Machine taps for ISO metric threads

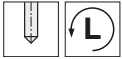

P	•
M	•
K	○
N	○
S	○
H	

Tool material	HSS-E
Tolerance on Ø	6HX
Surface	A
Type	VA R45
Form	C
Internal cooling	

DIN 371

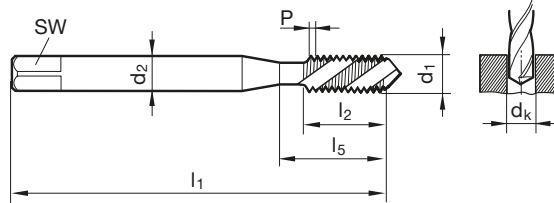

DIN 376

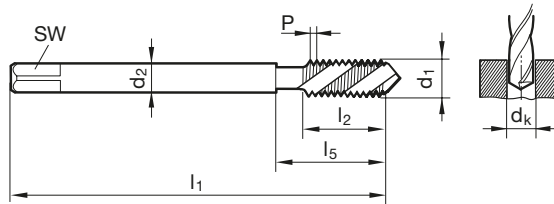

DIN 2184-1 DIN 371/DIN 376

Article no. **4629**

Discount group **103**

d1	P	d2	SW	dk	l1	l2	l5	Code no.	Availability
mm	mm	mm	mm	mm	mm	mm	mm		
M2	0.400	2.800	2.100	1.60	45.000	4.500	13.500	2.000	•
M2,5	0.450	2.800	2.100	2.05	50.000	5.000	14.500	2.500	•
M3	0.500	3.500	2.700	2.50	56.000	6.000	18.000	3.000	•
M3,5	0.600	4.000	3.000	2.90	56.000	7.000	20.000	3.500	•
M4	0.700	4.500	3.400	3.30	63.000	7.500	21.000	4.000	•
M5	0.800	6.000	4.900	4.20	70.000	8.500	25.000	5.000	•
M6	1.000	6.000	4.900	5.00	80.000	11.000	30.000	6.000	•
M8	1.250	8.000	6.200	6.80	90.000	14.000	35.000	8.000	•
M10	1.500	10.000	8.000	8.50	100.000	16.000	39.000	10.000	•
M12	1.750	9.000	7.000	10.20	110.000	18.500	49.000	12.000	•
M14	2.000	11.000	9.000	12.00	110.000	20.000	53.000	14.000	•
M16	2.000	12.000	9.000	14.00	110.000	20.000	54.000	16.000	•
M18	2.500	14.000	11.000	15.50	125.000	25.000	62.000	18.000	•
M20	2.500	16.000	12.000	17.50	140.000	25.000	62.000	20.000	•
M24	3.000	18.000	14.500	21.00	160.000	30.000	73.000	24.000	•
M30	3.500	22.000	18.000	26.50	180.000	35.000	85.000	30.000	•

Oil feed taps for ISO metric threads



P	•
M	•
K	○
N	○
S	○
H	

Tool material	HSS-E-PM
Tolerance on Ø	6HX
Surface	A
Type	VA R45
Form	C
Internal cooling	

DIN 371

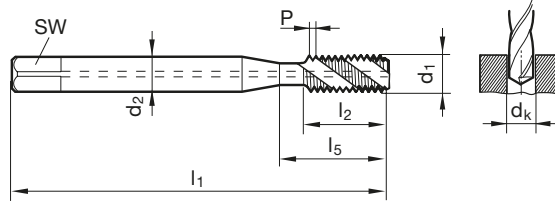

DIN 376

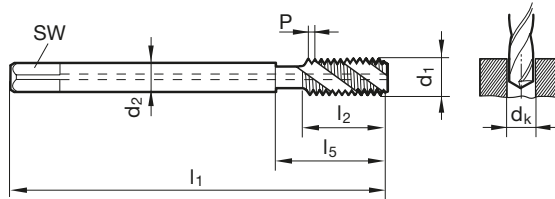

DIN 2184-1 DIN 371/DIN 376

Article no. **4636**

Discount group **103**

d1	P	d2	SW	dk	l1	l2	l5	Code no.	Availability
mm	mm	mm	mm	mm	mm	mm	mm		
M5	0.800	6.000	4.900	4.20	70.000	8.500	25.000	5.000	•
M6	1.000	6.000	4.900	5.00	80.000	11.000	30.000	6.000	•
M8	1.250	8.000	6.200	6.80	90.000	14.000	35.000	8.000	•
M10	1.500	10.000	8.000	8.50	100.000	16.000	39.000	10.000	•
M12	1.750	9.000	7.000	10.20	110.000	18.500	49.000	12.000	•
M14	2.000	11.000	9.000	12.00	110.000	20.000	53.000	14.000	•
M16	2.000	12.000	9.000	14.00	110.000	20.000	54.000	16.000	•
M20	2.500	16.000	12.000	17.50	140.000	25.000	62.000	20.000	•
M24	3.000	18.000	14.500	21.00	160.000	30.000	73.000	24.000	•
M30	3.500	22.000	18.000	26.50	180.000	35.000	85.000	30.000	•



Machine taps for ISO metric fine threads



P	•
M	•
K	○
N	○
S	○
H	

Tool material	HSS-E	
Tolerance on Ø	6HX	6GX
Surface	A	A
Type	VA R45	VA R45
Form	C	C
Internal cooling	<input type="checkbox"/>	<input type="checkbox"/>

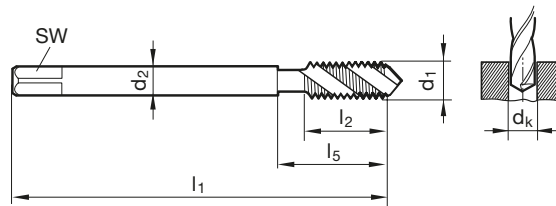

DIN 2184-1 DIN 374

Article no.

394

4628

Discount group

103

103

d1	d2	SW	dk	l1	l2	l5	Code no.	Availability	
	mm	mm	mm	mm	mm	mm			
M6 x 0,75	4.500	3.400	5.20	80.000	8.000	30.000	6.004	•	•
M8 x 0,75	6.000	4.900	7.20	80.000	8.000	30.000	8.004	•	•
M8 x 1	6.000	4.900	7.00	90.000	11.000	35.000	8.005	•	•
M10 x 1	7.000	5.500	9.00	90.000	11.000	35.000	10.005	•	•
M10 x 1,25	7.000	5.500	8.80	100.000	14.000	39.000	10.006	•	•
M12 x 1	9.000	7.000	11.00	100.000	11.000	40.000	12.005	•	•
M12 x 1,25	9.000	7.000	10.80	100.000	16.000	40.000	12.006	•	•
M12 x 1,5	9.000	7.000	10.50	100.000	16.000	40.000	12.007	•	•
M14 x 1,5	11.000	9.000	12.50	100.000	15.000	40.000	14.007	•	•
M16 x 1,5	12.000	9.000	14.50	100.000	15.000	44.000	16.007	•	•
M18 x 1,5	14.000	11.000	16.50	110.000	16.000	44.000	18.007	•	•
M20 x 1,5	16.000	12.000	18.50	125.000	16.000	44.000	20.007	•	•
M24 x 1,5	18.000	14.500	22.50	140.000	16.000	48.000	24.007	•	•

Machine taps for ISO metric fine threads



P	•
M	•
K	○
N	○
S	○
H	

Tool material	HSS-E-PM
Tolerance on Ø	6HX
Surface	A
Type	VA R45
Form	C
Internal cooling	

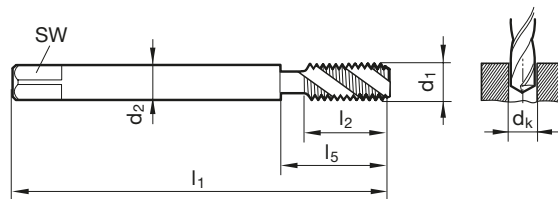

DIN 2184-1 DIN 374

Article no.

4635

Discount group

103

d1	d2	SW	dk	l1	l2	l5	Code no.	Availability
	mm	mm	mm	mm	mm	mm		
M8 x 1	6.000	4.900	7.00	90.000	11.000	35.000	8.005	•
M10 x 1	7.000	5.500	9.00	90.000	11.000	35.000	10.005	•
M10 x 1,25	7.000	5.500	8.80	100.000	14.000	39.000	10.006	•
M12 x 1	9.000	7.000	11.00	100.000	11.000	40.000	12.005	•
M12 x 1,25	9.000	7.000	10.80	100.000	16.000	40.000	12.006	•
M12 x 1,5	9.000	7.000	10.50	100.000	16.000	40.000	12.007	•
M14 x 1,5	11.000	9.000	12.50	100.000	15.000	40.000	14.007	•
M16 x 1,5	12.000	9.000	14.50	100.000	15.000	44.000	16.007	•
M18 x 1,5	14.000	11.000	16.50	110.000	16.000	44.000	18.007	•
M20 x 1,5	16.000	12.000	18.50	125.000	16.000	44.000	20.007	•
M24 x 1,5	18.000	14.500	22.50	140.000	16.000	48.000	24.007	•



Machine taps for ISO metric fine threads



P	•
M	•
K	○
N	○
S	○
H	

Tool material	HSS-E
Tolerance on Ø	6HX
Surface	A
Type	VA R45
Form	E
Internal cooling	

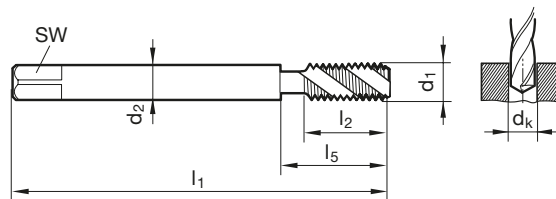

DIN 2184-1 DIN 374

Article no.

4631

Discount group

103

d1	d2	SW	dk	l1	l2	l5	Code no.	Availability
	mm	mm	mm	mm	mm	mm		
M6 x 0,75	4.500	3.400	5.20	80.000	8.000	30.000	6.004	•
M8 x 0,75	6.000	4.900	7.20	80.000	8.000	30.000	8.004	•
M8 x 1	6.000	4.900	7.00	90.000	11.000	35.000	8.005	•
M10 x 1	7.000	5.500	9.00	90.000	11.000	35.000	10.005	•
M10 x 1,25	7.000	5.500	8.80	100.000	14.000	39.000	10.006	•
M12 x 1	9.000	7.000	11.00	100.000	11.000	40.000	12.005	•
M12 x 1,25	9.000	7.000	10.80	100.000	16.000	40.000	12.006	•
M12 x 1,5	9.000	7.000	10.50	100.000	16.000	40.000	12.007	•
M14 x 1,5	11.000	9.000	12.50	100.000	15.000	40.000	14.007	•
M16 x 1,5	12.000	9.000	14.50	100.000	15.000	44.000	16.007	•
M18 x 1,5	14.000	11.000	16.50	110.000	16.000	44.000	18.007	•
M20 x 1,5	16.000	12.000	18.50	125.000	16.000	44.000	20.007	•
M24 x 1,5	18.000	14.500	22.50	140.000	16.000	48.000	24.007	•

Oil feed taps for ISO metric fine threads



P	•
M	•
K	○
N	○
S	○
H	

Tool material	HSS-E-PM
Tolerance on Ø	6HX
Surface	A
Type	VA R45
Form	C
Internal cooling	

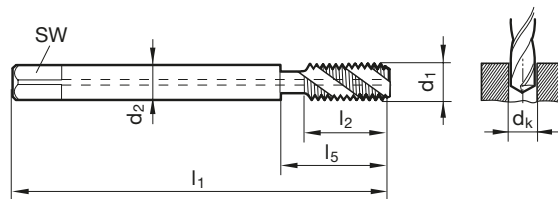

DIN 2184-1 DIN 374

Article no.

4637

Discount group

103

d1	d2	SW	dk	l1	l2	l5	Code no.	Availability
	mm	mm	mm	mm	mm	mm		
M8 x 1	6.000	4.900	7.00	90.000	11.000	35.000	8.005	•
M10 x 1	7.000	5.500	9.00	90.000	11.000	35.000	10.005	•
M10 x 1,25	7.000	5.500	8.80	100.000	14.000	39.000	10.006	•
M12 x 1	9.000	7.000	11.00	100.000	11.000	40.000	12.005	•
M12 x 1,25	9.000	7.000	10.80	100.000	16.000	40.000	12.006	•
M12 x 1,5	9.000	7.000	10.50	100.000	16.000	40.000	12.007	•
M14 x 1,5	11.000	9.000	12.50	100.000	15.000	40.000	14.007	•
M16 x 1,5	12.000	9.000	14.50	100.000	15.000	44.000	16.007	•
M18 x 1,5	14.000	11.000	16.50	110.000	16.000	44.000	18.007	•
M20 x 1,5	16.000	12.000	18.50	125.000	16.000	44.000	20.007	•
M24 x 1,5	18.000	14.500	22.50	140.000	16.000	48.000	24.007	•



Machine taps for UNC-threads



P	•
M	•
K	○
N	○
S	○
H	

Tool material	HSS-E
Tolerance on Ø	2BX
Surface	A
Type	VA R45
Form	C
Internal cooling	

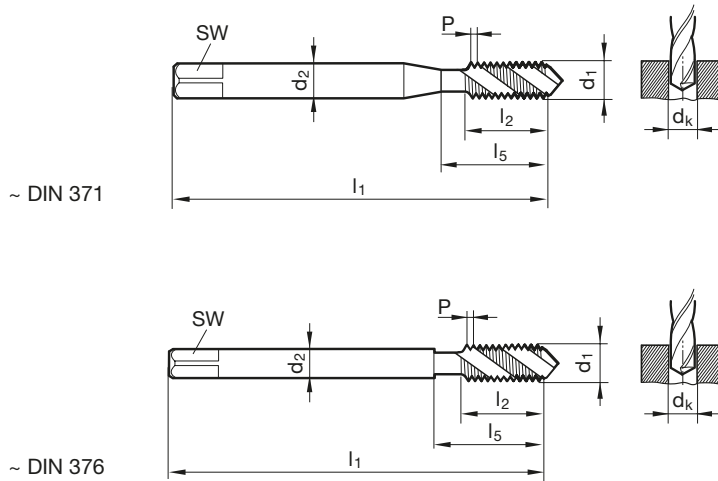

DIN 2184-1 ~DIN 371/~DIN 376

Article no.

391

Discount group

103

d1	d2	SW	dk	l1	l2	l5	Code no.	Availability
	mm	mm	mm	mm	mm	mm		
2 - 56	2.800	2.100	1.85	45.000	5.000	14.500	2.184	•
4 - 40	3.500	2.700	2.35	56.000	7.000	18.000	2.845	•
6 - 32	4.000	3.000	2.85	56.000	8.000	20.000	3.505	•
8 - 32	4.500	3.400	3.50	63.000	8.000	21.000	4.166	•
10 - 24	6.000	4.900	3.90	70.000	11.000	25.000	4.826	•
12 - 24	6.000	4.900	4.50	80.000	11.000	30.000	5.486	•
1/4 - 20	7.000	5.500	5.10	80.000	13.000	30.000	6.350	•
5/16 - 18	8.000	6.200	6.60	90.000	14.000	35.000	7.938	•
3/8 - 16	10.000	8.000	8.00	100.000	16.000	39.000	9.525	•
7/16 - 14	8.000	6.200	9.40	100.000	18.000	42.000	11.113	•
1/2 - 13	9.000	7.000	10.80	110.000	20.000	49.000	12.700	•
9/16 - 12	11.000	9.000	12.20	110.000	21.000	53.000	14.288	•
5/8 - 11	12.000	9.000	13.50	110.000	24.000	53.000	15.875	•
3/4 - 10	14.000	11.000	16.50	125.000	25.000	62.000	19.050	•
7/8 - 9	18.000	14.500	19.50	140.000	28.000	62.000	22.225	•
1 - 8	18.000	14.500	22.25	160.000	32.000	73.000	25.400	•

Machine taps for UNF-threads



P	•
M	•
K	○
N	○
S	○
H	

Tool material	HSS-E
Tolerance on Ø	2BX
Surface	A
Type	VA R45
Form	C
Internal cooling	

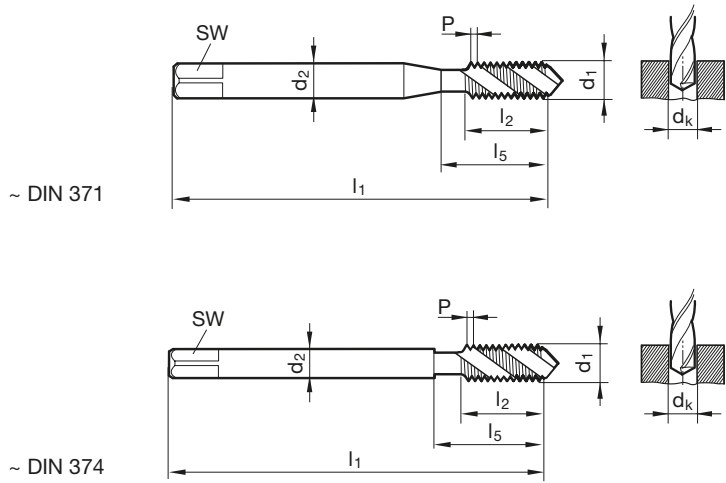

DIN 2184-1 ~DIN 371/~DIN 374 Article no. 392

Discount group 103

d1	d2	SW	dk	l1	l2	l5	Code no.	Availability
	mm	mm	mm	mm	mm	mm		
2 - 64	2.800	2.100	1.85	45.000	5.000	14.500	2.184	•
4 - 48	3.500	2.700	2.40	56.000	6.000	18.000	2.845	•
6 - 40	4.000	3.000	2.95	56.000	6.500	20.000	3.505	•
8 - 36	4.500	3.400	3.50	63.000	7.000	21.000	4.166	•
10 - 32	6.000	4.900	4.10	70.000	8.500	25.000	4.826	•
12 - 28	6.000	4.900	4.60	80.000	9.000	30.000	5.486	•
1/4 - 28	7.000	5.500	5.50	80.000	9.000	30.000	6.350	•
5/16 - 24	8.000	6.200	6.90	90.000	11.000	35.000	7.938	•
3/8 - 24	10.000	8.000	8.50	90.000	11.000	35.000	9.525	•
7/16 - 20	8.000	6.200	9.90	100.000	13.000	42.000	11.113	•
1/2 - 20	9.000	7.000	11.50	100.000	13.000	40.000	12.700	•
9/16 - 18	11.000	9.000	12.90	100.000	14.000	40.000	14.288	•
5/8 - 18	12.000	9.000	14.50	100.000	15.000	44.000	15.875	•
3/4 - 16	14.000	11.000	17.50	110.000	16.000	44.000	19.050	•
7/8 - 14	18.000	14.500	20.40	125.000	19.000	44.000	22.225	•
1 - 12	18.000	14.500	23.25	140.000	22.000	50.000	25.400	•



Machine taps for BSP-threads



P	•
M	•
K	○
N	○
S	○
H	

Tool material	HSS-E	
Tolerance on Ø	X	X
Surface	A	A
Type	VA R45	VA R45
Form	C	E
Internal cooling	<input type="checkbox"/>	<input type="checkbox"/>

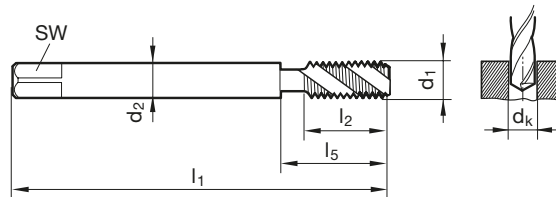

DIN 2184-1 DIN 5156

Article no.

395

4632

Discount group

103

103

d1	P	d2	SW	dk	l1	l2	l5	Code no.	Availability	
	inch	mm	mm	mm	mm	mm	mm			
G1/16	28.000	6.000	4.900	6.80	90.000	11.000	30.000	7.723	•	•
G1/8	28.000	7.000	5.500	8.80	90.000	11.000	35.000	9.728	•	•
G1/4	19.000	11.000	9.000	11.80	100.000	14.000	40.000	13.157	•	•
G3/8	19.000	12.000	9.000	15.25	100.000	14.000	44.000	16.662	•	•
G1/2	14.000	16.000	12.000	19.00	125.000	18.000	44.000	20.955	•	•
G5/8	14.000	18.000	14.500	21.00	125.000	18.000	48.000	22.911	•	•
G3/4	14.000	20.000	16.000	24.50	140.000	20.000	53.000	26.441	•	•
G7/8	14.000	22.000	18.000	28.25	150.000	22.000	53.000	30.201	•	•
G1	11.000	25.000	20.000	30.75	160.000	24.000	56.000	33.249	•	•

Machine taps for ISO metric threads



P	•
M	•
K	○
N	○
S	○
H	

Tool material	HSS-E			
Tolerance on Ø	6HX	6GX	7GX	6H+0,1
Surface	S	S	S	S
Type	VA	VA	VA	VA
Form	B	B	B	B
Internal cooling	<input type="checkbox"/>	<input type="checkbox"/>	<input type="checkbox"/>	<input type="checkbox"/>

DIN 371

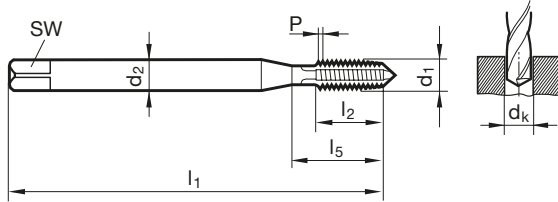

DIN 376

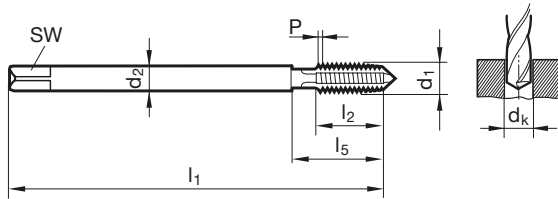

DIN 2184-1 DIN 371/DIN 376

Article no. 4218 4638 4639 4640

Discount group 103 103 103 103

d1	P	d2	SW	dk	l1	l2	l5	Code no.	Availability
	mm	mm	mm	mm	mm	mm	mm		
M2	0.400	2.800	2.100	1.60	45.000	8.000	13.500	2.000	• • • •
M2,5	0.450	2.800	2.100	2.05	50.000	9.000	14.500	2.500	• • • •
M3	0.500	3.500	2.700	2.50	56.000	10.000	18.000	3.000	• • • •
M4	0.700	4.500	3.400	3.30	63.000	12.000	21.000	4.000	• • • •
M5	0.800	6.000	4.900	4.20	70.000	14.000	25.000	5.000	• • • •
M6	1.000	6.000	4.900	5.00	80.000	16.000	30.000	6.000	• • • •
M8	1.250	8.000	6.200	6.80	90.000	17.000	35.000	8.000	• • • •
M10	1.500	10.000	8.000	8.50	100.000	20.000	39.000	10.000	• • • •
M12	1.750	9.000	7.000	10.20	110.000	24.000	49.000	12.000	• • • •
M14	2.000	11.000	9.000	12.00	110.000	26.000	53.000	14.000	• • • •
M16	2.000	12.000	9.000	14.00	110.000	26.000	54.000	16.000	• • • •
M18	2.500	14.000	11.000	15.50	125.000	30.000	62.000	18.000	• • • •
M20	2.500	16.000	12.000	17.50	140.000	32.000	62.000	20.000	• • • •
M24	3.000	18.000	14.500	21.00	160.000	36.000	73.000	24.000	• • • •
M30	3.500	22.000	18.000	26.50	180.000	40.000	85.000	30.000	• • • •



Machine taps for ISO metric threads



P	•
M	•
K	○
N	○
S	○
H	

Tool material	HSS-E-PM
Tolerance on Ø	6HX
Surface	S
Type	VA
Form	B
Internal cooling	

DIN 371

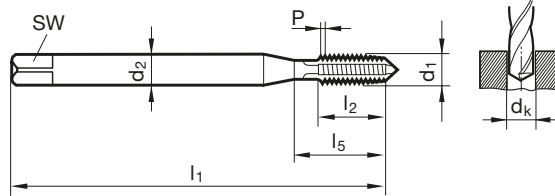

DIN 376

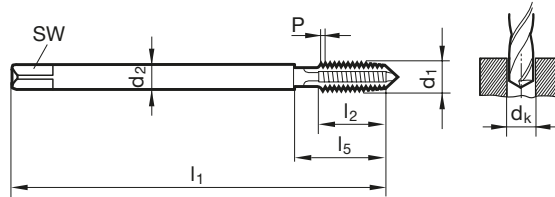

DIN 2184-1 DIN 371/DIN 376

Article no. **4646**

Discount group **103**

d1	P	d2	SW	dk	l1	l2	l5	Code no.	Availability
	mm	mm	mm	mm	mm	mm	mm		
M3	0.500	3.500	2.700	2.50	56.000	10.000	18.000	3.000	•
M4	0.700	4.500	3.400	3.30	63.000	12.000	21.000	4.000	•
M5	0.800	6.000	4.900	4.20	70.000	14.000	25.000	5.000	•
M6	1.000	6.000	4.900	5.00	80.000	16.000	30.000	6.000	•
M8	1.250	8.000	6.200	6.80	90.000	17.000	35.000	8.000	•
M10	1.500	10.000	8.000	8.50	100.000	20.000	39.000	10.000	•
M12	1.750	9.000	7.000	10.20	110.000	24.000	49.000	12.000	•
M14	2.000	11.000	9.000	12.00	110.000	26.000	53.000	14.000	•
M16	2.000	12.000	9.000	14.00	110.000	26.000	54.000	16.000	•
M20	2.500	16.000	12.000	17.50	140.000	32.000	62.000	20.000	•

Machine taps for ISO metric threads



P	•
M	•
K	○
N	○
S	○
H	

Tool material	HSS-E-PM
Tolerance on Ø	6HX
Surface	S
Type	VA
Form	B
Internal cooling	

DIN 371

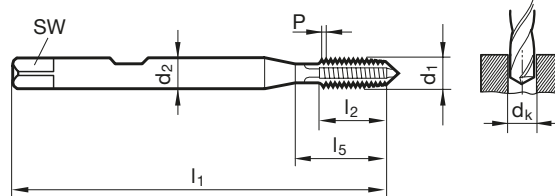

DIN 376

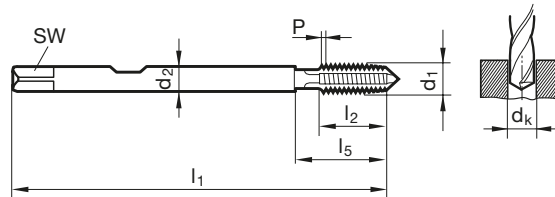

DIN 2184-1 DIN 371/DIN 376

Article no. 4651

Discount group 103

d1	P	d2	SW	dk	l1	l2	l5	Code no.	Availability
mm	mm	mm	mm	mm	mm	mm	mm		
M3	0.500	6.000	4.900	2.50	56.000	10.000	18.000	3.000	•
M4	0.700	6.000	4.900	3.30	63.000	12.000	21.000	4.000	•
M5	0.800	6.000	4.900	4.20	70.000	14.000	25.000	5.000	•
M6	1.000	6.000	4.900	5.00	80.000	16.000	30.000	6.000	•
M8	1.250	8.000	6.200	6.80	90.000	17.000	35.000	8.000	•
M10	1.500	10.000	8.000	8.50	100.000	20.000	39.000	10.000	•
M12	1.750	12.000	9.000	10.20	110.000	24.000	49.000	12.000	•
M14	2.000	12.000	9.000	12.00	110.000	26.000	53.000	14.000	•
M16	2.000	12.000	9.000	14.00	110.000	26.000	54.000	16.000	•
M20	2.500	16.000	12.000	17.50	140.000	32.000	62.000	20.000	•



Machine taps for ISO metric threads

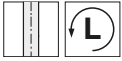

P	•
M	•
K	○
N	○
S	○
H	

Tool material	HSS-E
Tolerance on Ø	6HX
Surface	S
Type	VA
Form	B
Internal cooling	

DIN 371

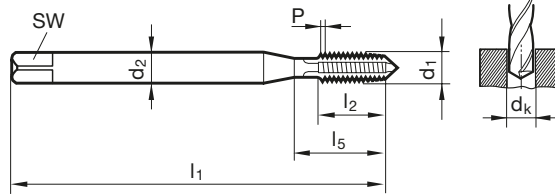

DIN 376

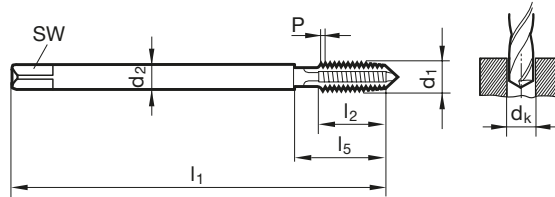

DIN 2184-1 DIN 371/DIN 376

Article no. **4644**

Discount group **103**

d1	P	d2	SW	dk	l1	l2	l5	Code no.	Availability
	mm	mm	mm	mm	mm	mm	mm		
M2	0.400	2.800	2.100	1.60	45.000	8.000	13.500	2.000	•
M2,5	0.450	2.800	2.100	2.05	50.000	9.000	14.500	2.500	•
M3	0.500	3.500	2.700	2.50	56.000	10.000	18.000	3.000	•
M4	0.700	4.500	3.400	3.30	63.000	12.000	21.000	4.000	•
M5	0.800	6.000	4.900	4.20	70.000	14.000	25.000	5.000	•
M6	1.000	6.000	4.900	5.00	80.000	16.000	30.000	6.000	•
M8	1.250	8.000	6.200	6.80	90.000	17.000	35.000	8.000	•
M10	1.500	10.000	8.000	8.50	100.000	20.000	39.000	10.000	•
M12	1.750	9.000	7.000	10.20	110.000	24.000	49.000	12.000	•
M14	2.000	11.000	9.000	12.00	110.000	26.000	53.000	14.000	•
M16	2.000	12.000	9.000	14.00	110.000	26.000	54.000	16.000	•
M18	2.500	14.000	11.000	15.50	125.000	30.000	62.000	18.000	•
M20	2.500	16.000	12.000	17.50	140.000	32.000	62.000	20.000	•
M24	3.000	18.000	14.500	21.00	160.000	36.000	73.000	24.000	•
M30	3.500	22.000	18.000	26.50	180.000	40.000	85.000	30.000	•

Machine taps for ISO metric threads



P	•
M	•
K	○
N	○
S	○
H	

Tool material	HSS-E
Tolerance on Ø	6HX
Surface	S
Type	VA
Form	B
Internal cooling	

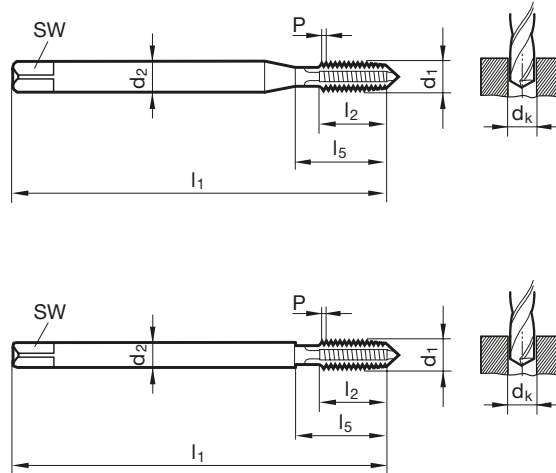

Company std.	Article no.	4645
--------------	-------------	------

Discount group	103
----------------	-----

d1	P	d2	SW	dk	l1	l2	l5	Code no.	Availability
mm	mm	mm	mm	mm	mm	mm	mm		
M3	0.500	3.500	2.700	2.50	90.000	10.000	18.000	3.000	•
M4	0.700	4.500	3.400	3.30	125.000	12.000	21.000	4.000	•
M5	0.800	6.000	4.900	4.20	140.000	14.000	25.000	5.000	•
M6	1.000	6.000	4.900	5.00	160.000	16.000	30.000	6.000	•
M8	1.250	8.000	6.200	6.80	180.000	17.000	35.000	8.010	•
M10	1.500	10.000	8.000	8.50	200.000	20.000	39.000	10.010	•
M12	1.750	9.000	7.000	10.20	220.000	24.000	158.000	12.000	•
M14	2.000	11.000	9.000	12.00	220.000	26.000	160.000	14.000	•
M16	2.000	12.000	9.000	14.00	220.000	26.000	160.000	16.000	•
M20	2.500	16.000	12.000	17.50	280.000	32.000	217.000	20.000	•



Oil feed taps for ISO metric threads



P	•
M	•
K	○
N	○
S	○
H	

Tool material	HSS-E-PM
Tolerance on Ø	6HX
Surface	S
Type	VA
Form	B
Internal cooling	

DIN 371

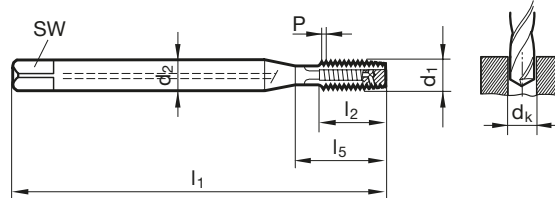

DIN 376

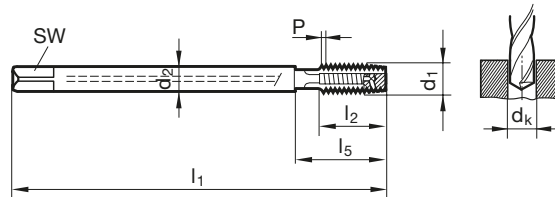

DIN 2184-1 DIN 371/DIN 376

Article no. 4648

Discount group 103

d1	P	d2	SW	dk	l1	l2	l5	Code no.	Availability
mm	mm	mm	mm	mm	mm	mm	mm		
M5	0.800	6.000	4.900	4.20	70.000	14.000	25.000	5.000	•
M6	1.000	6.000	4.900	5.00	80.000	16.000	30.000	6.000	•
M8	1.250	8.000	6.200	6.80	90.000	17.000	35.000	8.000	•
M10	1.500	10.000	8.000	8.50	100.000	20.000	39.000	10.000	•
M12	1.750	9.000	7.000	10.20	110.000	24.000	49.000	12.000	•
M14	2.000	11.000	9.000	12.00	110.000	26.000	53.000	14.000	•
M16	2.000	12.000	9.000	14.00	110.000	26.000	54.000	16.000	•
M20	2.500	16.000	12.000	17.50	140.000	32.000	62.000	20.000	•
M24	3.000	18.000	14.500	21.00	160.000	36.000	73.000	24.000	•
M30	3.500	22.000	18.000	26.50	180.000	40.000	85.000	30.000	•

Machine taps for ISO metric fine threads



P	•
M	•
K	○
N	○
S	○
H	

Tool material	HSS-E		HSS-E-PM
Tolerance on Ø	6HX	6GX	6HX
Surface	S	S	S
Type	VA	VA	VA
Form	B	B	B
Internal cooling			

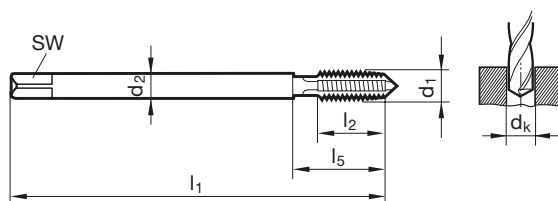

DIN 2184-1 DIN 374

Article no.

4219

4641

4647

Discount group

103

103

103

d1	d2	SW	dk	l1	l2	l5	Code no.	Availability		
	mm	mm	mm	mm	mm	mm				
M6 x 0,75	4.500	3.400	5.20	80.000	13.000	30.000	6.004	•	•	
M8 x 0,75	6.000	4.900	7.20	80.000	14.000	30.000	8.004	•	•	
M8 x 1	6.000	4.900	7.00	90.000	17.000	35.000	8.005	•	•	•
M10 x 1	7.000	5.500	9.00	90.000	16.000	35.000	10.005	•	•	•
M10 x 1,25	7.000	5.500	8.80	100.000	20.000	39.000	10.006	•	•	•
M12 x 1	9.000	7.000	11.00	100.000	20.000	40.000	12.005	•	•	•
M12 x 1,25	9.000	7.000	10.80	100.000	20.000	40.000	12.006	•	•	•
M12 x 1,5	9.000	7.000	10.50	100.000	20.000	40.000	12.007	•	•	•
M14 x 1,5	11.000	9.000	12.50	100.000	20.000	40.000	14.007	•	•	•
M16 x 1,5	12.000	9.000	14.50	100.000	22.000	44.000	16.007	•	•	•
M18 x 1,5	14.000	11.000	16.50	110.000	25.000	44.000	18.007	•	•	•
M20 x 1,5	16.000	12.000	18.50	125.000	25.000	44.000	20.007	•	•	•
M24 x 1,5	18.000	14.500	22.50	140.000	28.000	48.000	24.007	•	•	•



Oil feed taps for ISO metric fine threads



P	•
M	•
K	○
N	○
S	○
H	

Tool material	HSS-E-PM
Tolerance on Ø	6HX
Surface	S
Type	VA
Form	B
Internal cooling	

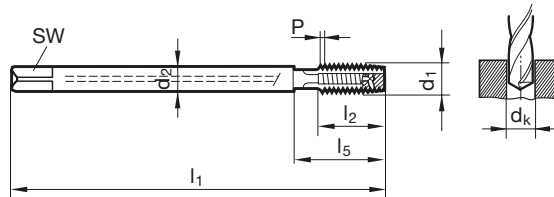

DIN 2184-1 DIN 374

Article no.

4649

Discount group

103

d1	d2	SW	dk	l1	l2	l5	Code no.	Availability
	mm	mm	mm	mm	mm	mm		
M8 x 1	6.000	4.900	7.00	90.000	17.000	35.000	8.005	•
M10 x 1	7.000	5.500	9.00	90.000	16.000	35.000	10.005	•
M10 x 1,25	7.000	5.500	8.80	100.000	20.000	39.000	10.006	•
M12 x 1	9.000	7.000	11.00	100.000	20.000	40.000	12.005	•
M12 x 1,25	9.000	7.000	10.80	100.000	20.000	40.000	12.006	•
M12 x 1,5	9.000	7.000	10.50	100.000	20.000	40.000	12.007	•
M14 x 1,5	11.000	9.000	12.50	100.000	20.000	40.000	14.007	•
M16 x 1,5	12.000	9.000	14.50	100.000	22.000	44.000	16.007	•
M18 x 1,5	14.000	11.000	16.50	110.000	25.000	44.000	18.007	•
M20 x 1,5	16.000	12.000	18.50	125.000	25.000	44.000	20.007	•
M24 x 1,5	18.000	14.500	22.50	140.000	28.000	48.000	24.007	•

Machine taps for UNC-threads



P	•
M	•
K	○
N	○
S	○
H	

Tool material	HSS-E
Tolerance on Ø	2BX
Surface	S
Type	VA
Form	B
Internal cooling	

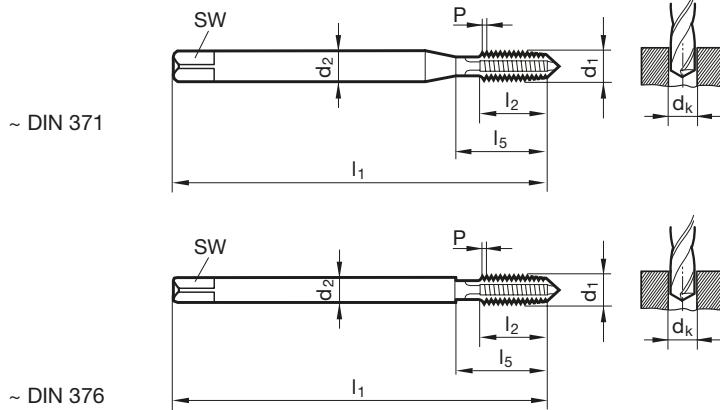

DIN 2184-1 ~DIN 371/~DIN 376

Article no.

4642

Discount group

103

d1	d2	SW	dk	l1	l2	l5	Code no.	Availability
	mm	mm	mm	mm	mm	mm		
2 - 56	2.800	2.100	1.85	45.000	9.000	14.500	2.184	•
4 - 40	3.500	2.700	2.35	56.000	11.000	18.000	2.845	•
6 - 32	4.000	3.000	2.85	56.000	12.000	20.000	3.505	•
8 - 32	4.500	3.400	3.50	63.000	12.000	21.000	4.166	•
10 - 24	6.000	4.900	3.90	70.000	14.000	25.000	4.826	•
12 - 24	6.000	4.900	4.50	80.000	16.000	30.000	5.486	•
1/4 - 20	7.000	5.500	5.10	80.000	16.000	30.000	6.350	•
5/16 - 18	8.000	6.200	6.60	90.000	18.000	35.000	7.938	•
3/8 - 16	10.000	8.000	8.00	100.000	20.000	39.000	9.525	•
7/16 - 14	8.000	6.200	9.40	100.000	22.000	42.000	11.113	•
1/2 - 13	9.000	7.000	10.80	110.000	25.000	49.000	12.700	•
9/16 - 12	11.000	9.000	12.20	110.000	28.000	53.000	14.288	•
5/8 - 11	12.000	9.000	13.50	110.000	30.000	53.000	15.875	•
3/4 - 10	14.000	11.000	16.50	125.000	33.000	62.000	19.050	•
7/8 - 9	18.000	14.500	19.50	140.000	35.000	62.000	22.225	•
1 - 8	18.000	14.500	22.25	160.000	38.000	73.000	25.400	•



Machine taps for UNF-threads



P	•
M	•
K	○
N	○
S	○
H	

Tool material	HSS-E
Tolerance on Ø	2BX
Surface	S
Type	VA
Form	B
Internal cooling	

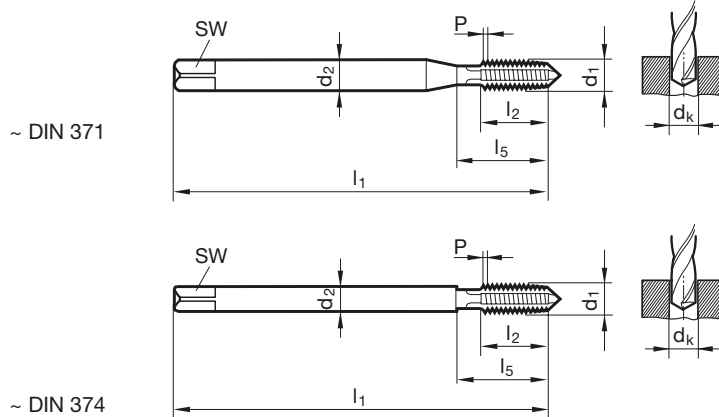

DIN 2184-1 ~DIN 371/~DIN 374

Article no.

4643

Discount group

103

d1	d2	SW	dk	l1	l2	l5	Code no.	Availability
	mm	mm	mm	mm	mm	mm		
2 - 64	2.800	2.100	1.85	45.000	9.000	14.500	2.184	•
4 - 48	3.500	2.700	2.40	56.000	10.000	18.000	2.845	•
6 - 40	4.000	3.000	2.95	56.000	11.000	20.000	3.505	•
8 - 36	4.500	3.400	3.50	63.000	12.000	21.000	4.166	•
10 - 32	6.000	4.900	4.10	70.000	14.000	25.000	4.826	•
12 - 28	6.000	4.900	4.60	80.000	16.000	30.000	5.486	•
1/4 - 28	7.000	5.500	5.50	80.000	16.000	30.000	6.350	•
5/16 - 24	8.000	6.200	6.90	90.000	18.000	35.000	7.938	•
3/8 - 24	10.000	8.000	8.50	90.000	18.000	35.000	9.525	•
7/16 - 20	8.000	6.200	9.90	100.000	22.000	42.000	11.113	•
1/2 - 20	9.000	7.000	11.50	100.000	20.000	40.000	12.700	•
9/16 - 18	11.000	9.000	12.90	100.000	22.000	40.000	14.288	•
5/8 - 18	12.000	9.000	14.50	100.000	22.000	44.000	15.875	•
3/4 - 16	14.000	11.000	17.50	110.000	25.000	44.000	19.050	•
7/8 - 14	18.000	14.500	20.40	125.000	25.000	44.000	22.225	•
1 - 12	18.000	14.500	23.25	140.000	28.000	50.000	25.400	•

Machine taps for BSP-threads



P	•
M	•
K	○
N	○
S	○
H	

Tool material	HSS-E
Tolerance on Ø	X
Surface	S
Type	VA
Form	B
Internal cooling	

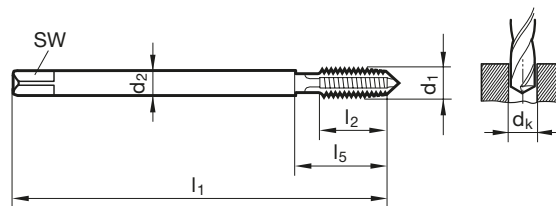

DIN 2184-1 DIN 5156

Article no.

4220

Discount group

103

d1	P	d2	SW	dk	l1	l2	l5	Code no.	Availability
	inch	mm	mm	mm	mm	mm	mm		
G1/16	28.000	6.000	4.900	6.80	90.000	18.000	30.000	7.723	•
G1/8	28.000	7.000	5.500	8.80	90.000	18.000	35.000	9.728	•
G1/4	19.000	11.000	9.000	11.80	100.000	20.000	40.000	13.157	•
G3/8	19.000	12.000	9.000	15.25	100.000	22.000	44.000	16.662	•
G1/2	14.000	16.000	12.000	19.00	125.000	25.000	44.000	20.955	•
G5/8	14.000	18.000	14.500	21.00	125.000	25.000	48.000	22.911	•
G3/4	14.000	20.000	16.000	24.50	140.000	28.000	53.000	26.441	•
G7/8	14.000	22.000	18.000	28.25	150.000	28.000	53.000	30.201	•
G1	11.000	25.000	20.000	30.75	160.000	30.000	56.000	33.249	•

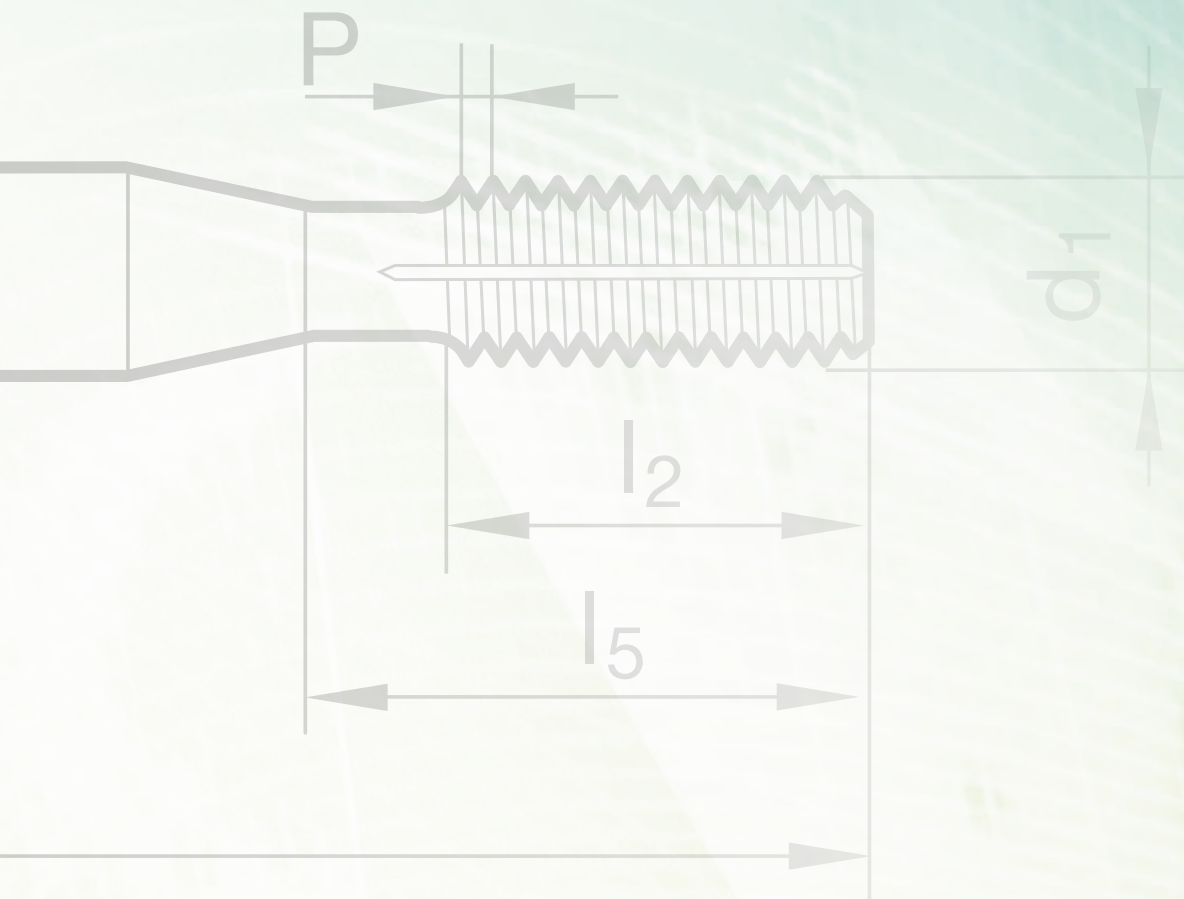

FLUTELESS TAPS

	Thread depth	≤3xD																																																							
	Tool material	HSS-E-PM																																																							
	Lead form	C	E	C	E																																																				
	Surface																																																								
	Coolant delivery																																																								
	Shank tolerance	h6	h6	h6	h6																																																				
 THROUGH HOLE BLIND HOLE																																																									
<ul style="list-style-type: none"> ● = Neat oil ○ = Soluble oil △ = Paste □ = MQL 	<table border="1"> <thead> <tr> <th>Thread type</th> <th>Tolerance</th> <th colspan="4">Article no./page</th> </tr> </thead> <tbody> <tr> <td rowspan="2">M</td> <td>6HX</td> <td>4487 p. 35</td> <td>4494 p. 35</td> <td>4485 p. 37</td> <td>4483 p. 36</td> </tr> <tr> <td>6GX</td> <td>4488 p. 35</td> <td></td> <td></td> <td></td> </tr> <tr> <td rowspan="2">MF</td> <td>6HX</td> <td>4489 p. 38</td> <td>4495 p. 38</td> <td>4486 p. 40</td> <td>4484 p. 39</td> </tr> <tr> <td>6GX</td> <td>4490 p. 38</td> <td></td> <td></td> <td></td> </tr> <tr> <td>UNC</td> <td>2BX</td> <td>4491 p. 41</td> <td></td> <td></td> <td></td> </tr> <tr> <td>UNF</td> <td>2BX</td> <td>4492 p. 42</td> <td></td> <td></td> <td></td> </tr> <tr> <td>G</td> <td>- X</td> <td>4493 p. 43</td> <td></td> <td></td> <td></td> </tr> <tr> <td colspan="2">Suitable lubricant:</td> <td>○/●/△</td> <td>○/●/△</td> <td>○/●/△/□</td> <td>○/●/△/□</td> </tr> </tbody> </table>	Thread type	Tolerance	Article no./page				M	6HX	4487 p. 35	4494 p. 35	4485 p. 37	4483 p. 36	6GX	4488 p. 35				MF	6HX	4489 p. 38	4495 p. 38	4486 p. 40	4484 p. 39	6GX	4490 p. 38				UNC	2BX	4491 p. 41				UNF	2BX	4492 p. 42				G	- X	4493 p. 43				Suitable lubricant:		○/●/△	○/●/△	○/●/△/□	○/●/△/□				
Thread type	Tolerance	Article no./page																																																							
M	6HX	4487 p. 35	4494 p. 35	4485 p. 37	4483 p. 36																																																				
	6GX	4488 p. 35																																																							
MF	6HX	4489 p. 38	4495 p. 38	4486 p. 40	4484 p. 39																																																				
	6GX	4490 p. 38																																																							
UNC	2BX	4491 p. 41																																																							
UNF	2BX	4492 p. 42																																																							
G	- X	4493 p. 43																																																							
Suitable lubricant:		○/●/△	○/●/△	○/●/△/□	○/●/△/□																																																				

		Group of materials	Tensile strength	Material example	Material no.	Recommended cutting speed v _c [m/min]			
P	P1	Structural and free cutting steels, heat-treatable steels unalloyed	≤800 N/mm ²	S235JR C15 11SMnPb30	1.0037 1.0401 1.0718	25	25	25	25
	P2	Free-cutting steels, unalloyed case hardened steels, nitriding steels	800 - 1000 N/mm ²	S355J2 C60 31CrMo12	1.0577 1.0601 1.8515	25	25	25	25
	P3	Alloyed heat-treatable steels, tool steels, high speed steels	800 - 1200 N/mm ²	42CrMo4 36CrNiMo4 X36CrMo17 HS 6-5-2	1.7225 1.6511 1.2316 1.3343	15	15	15	15
M	M1	Stainless steels, sulphured, austenitic	≤1000 N/mm ²	X5CrNi18-10 X6CrNiTi18-10 X8CrNiS18-9	1.4301 1.4571 1.4305	15	15	15	15
	M2	Stainless- and acidresistant steels, martensitic	≤1000 N/mm ²	X17CrNi16-2 X90CrMoV18 X2CrTi12	1.4057 1.4112 1.4512	10	10	10	10
	M3	Duplex and Super Duplex	≤1300 N/mm ²	X2CrNiMoN22-5-3 X2CrNiMoN25-7-4 X2CrNiMoCuWN25-7-4	1.4462 1.4410 1.4501	6	6	6	6
K	K1	Cast Iron	300 HB	EN-GJL-150 EN-GJL-250 EN-GJL-300	0.6015 0.6025 0.6030				
	K2	Spheroidal graphite iron and malleable cast iron	350 HB	EN-GJS-400-15 EN-GJS-600-3 EN-GJS-700-2	0.7040 0.7060 0.7070	30	30	30	30
	K3	ADI GGV	1000 N/mm ² 350 HB	EN-GJS1000-5 EN-GJV250 EN-GJV400		25	25	25	25
N	N1	Aluminium and wrought alloys	≤450 N/mm ²	Al99,5H AlMgSi1 AlZn4,5Mg	3.0250 3.2315 3.4335	15	15	15	15
	N2	Al cast alloys	≤600 N/mm ²	GD-AISi5Cu1Mg GD-AISi8Cu3 G-AISi9Mg G-AISi12	3.2134 3.2162 3.2373 3.2581	30	30	30	30
	N3	Magnesium alloys	≤500 N/mm ²	GDMgAl8Zn1	3.5812.08				
	N4	Copper and copper alloys	long-chipping	CuZn20 CuZn37Pb0,5	2.0250 2.0332	30	30	30	30
			short-chipping	CuZn39Pb2 CuZn43Pb2	2.0380 2.0410				
	N5	Copper special alloys	≤1400 N/mm ²	Ampco					
N6	Plastics [Thermoplastics, Duroplastics]	long-chipping short-chipping	PMMA, POM, PVC Pertinax						
S	S1	Titanium and Titanium alloys	≤ 1200 N/mm ²	Titan TiAl5Sn2 TiAl6V4	3.702<5 3.7115 3.7165	8	8	8	8
	S2	Nickel, cobalt, iron alloys	≤ 1400 N/mm ²	Hastelloy C4 Inconel 718 Nimonic 105	2.4610 2.4668 2.4634	8	8	8	8
H	H1	High tensile/ hardened steels	45 - 55 HRC						
	H2		55 - 62 HRC						



Fluteless machine taps for ISO metric threads



P	•
M	•
K	•
N	○
S	•
H	

Tool material	HSS-E-PM		
Tolerance on Ø	4HX/6HX	6GX	6HX
Surface	Ⓢ	Ⓢ	Ⓢ
Type	N	N	N
Form	C	C	E
Internal cooling	⊗	⊗	⊗

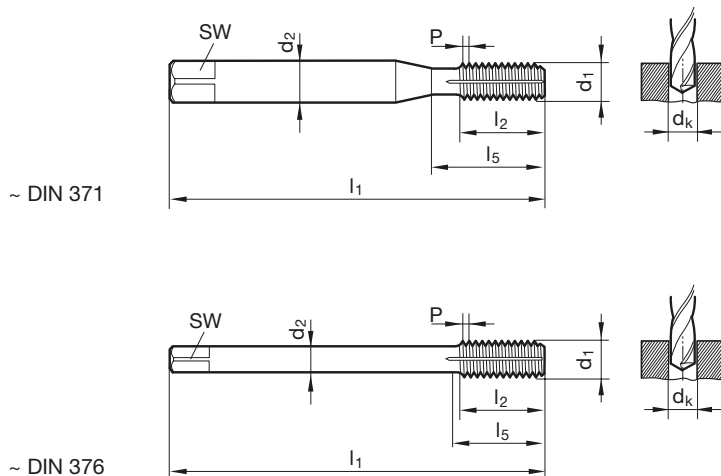

DIN 2174 ~DIN 371/~DIN 376

Article no. 4487 4488 4494

Discount group 208 208 208

d1	P	d2	SW	dk	l1	l2	l5	Code no.	Availability		
mm	mm	mm	mm	mm	mm	mm	mm				
M1	0.250	2.500	2.100	0.90	40.000	4.000		1.000	•		
M1,2	0.250	2.500	2.100	1.10	40.000	4.800		1.200	•		
M1,4	0.300	2.500	2.100	1.25	40.000	5.600		1.400	•		
M1,6	0.350	2.500	2.100	1.45	40.000	6.400		1.600	•		
M1,7	0.350	2.500	2.100	1.55	40.000	6.800		1.700	•		
M1,8	0.350	2.500	2.100	1.65	40.000	7.300		1.800	•		
M2	0.400	2.800	2.100	1.85	45.000	8.000	13.500	2.000	•	•	•
M2,5	0.450	2.800	2.100	2.30	50.000	9.000	14.500	2.500	•	•	•
M3	0.500	3.500	2.700	2.80	56.000	10.000	18.000	3.000	•	•	•
M4	0.700	4.500	3.400	3.70	63.000	12.000	21.000	4.000	•	•	•
M5	0.800	6.000	4.900	4.65	70.000	14.000	25.000	5.000	•	•	•
M6	1.000	6.000	4.900	5.55	80.000	16.000	30.000	6.000	•	•	•
M8	1.250	8.000	6.200	7.40	90.000	17.000	35.000	8.000	•	•	•
M10	1.500	10.000	8.000	9.30	100.000	20.000	39.000	10.000	•	•	•
M12	1.750	9.000	7.000	11.20	110.000	24.000	49.000	12.000	•	•	•
M14	2.000	11.000	9.000	13.10	110.000	26.000	53.000	14.000	•	•	•
M16	2.000	12.000	9.000	15.10	110.000	26.000	54.000	16.000	•	•	•
M20	2.500	16.000	12.000	18.90	140.000	32.000	62.000	20.000	•	•	•

Article no. 4487 from Ø M2 with oil grooves, Ø tolerance ≤ M1.4 = 4HX

Oil feed fluteless taps f. ISO metric threads



P	•
M	•
K	•
N	○
S	•
H	

Tool material	HSS-E-PM
Tolerance on Ø	6HX
Surface	Ⓢ
Type	N
Form	E
Internal cooling	

~ DIN 371

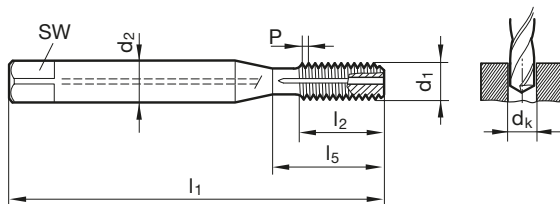

~ DIN 376

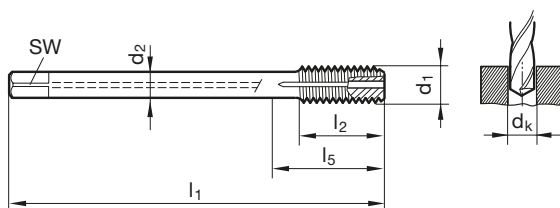

DIN 2174 ~DIN 371/~DIN 376

Article no. 4483

Discount group 208

d1	P	d2	SW	dk	l1	l2	l5	Code no.	Availability
	mm	mm	mm	mm	mm	mm	mm		
M5	0.800	6.000	4.900	4.65	70.000	8.500	25.000	5.000	•
M6	1.000	6.000	4.900	5.55	80.000	11.000	30.000	6.000	•
M8	1.250	8.000	6.200	7.40	90.000	14.000	35.000	8.000	•
M10	1.500	10.000	8.000	9.30	100.000	16.000	39.000	10.000	•
M12	1.750	9.000	7.000	11.20	110.000	18.500	49.000	12.000	•
M14	2.000	11.000	9.000	13.10	110.000	20.000	53.000	14.000	•
M16	2.000	12.000	9.000	15.10	110.000	20.000	54.000	16.000	•
M20	2.500	16.000	12.000	18.90	140.000	25.000	62.000	20.000	•



Oil feed fluteless taps f. ISO metric threads



P	•
M	•
K	•
N	○
S	•
H	

Tool material	HSS-E-PM
Tolerance on Ø	6HX
Surface	Ⓢ
Type	N
Form	C
Internal cooling	

~ DIN 371

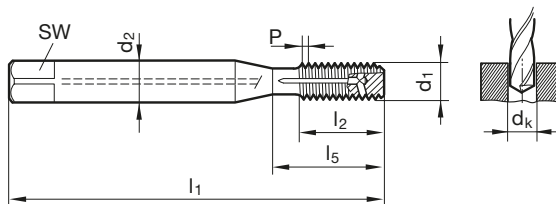

~ DIN 376

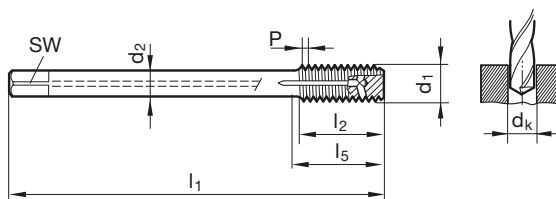

DIN 2174 ~DIN 371/~DIN 376

Article no. **4485**

Discount group **208**

d1	P	d2	SW	dk	l1	l2	l5	Code no.	Availability
	mm	mm	mm	mm	mm	mm	mm		
M5	0.800	6.000	4.900	4.65	70.000	8.500	25.000	5.000	•
M6	1.000	6.000	4.900	5.55	80.000	11.000	30.000	6.000	•
M8	1.250	8.000	6.200	7.40	90.000	14.000	35.000	8.000	•
M10	1.500	10.000	8.000	9.30	100.000	16.000	39.000	10.000	•
M12	1.750	9.000	7.000	11.20	110.000	18.500	49.000	12.000	•
M14	2.000	11.000	9.000	13.10	110.000	20.000	53.000	14.000	•
M16	2.000	12.000	9.000	15.10	110.000	20.000	54.000	16.000	•
M20	2.500	16.000	12.000	18.90	140.000	25.000	62.000	20.000	•

Fluteless machine taps for ISO metric fine threads



P	•
M	•
K	•
N	○
S	•
H	

Tool material	HSS-E-PM		
Tolerance on Ø	6HX	6GX	6HX
Surface	Ⓢ	Ⓢ	Ⓢ
Type	N	N	N
Form	C	C	E
Internal cooling	☒	☒	☒

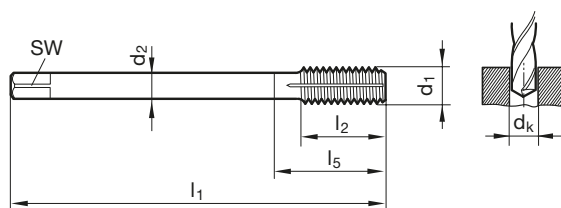

DIN 2174 ~DIN 374

Article no. 4489 4490 4495

Discount group 208 208 208

d1	d2	SW	dk	l1	l2	l5	Code no.	Availability		
	mm	mm	mm	mm	mm	mm				
M8 x 1	6.000	4.900	7.55	90.000	16.000	35.000	8.005	•	•	•
M10 x 1	7.000	5.500	9.55	90.000	16.000	35.000	10.005	•	•	•
M10 x 1,25	7.000	5.500	9.40	100.000	20.000	39.000	10.006	•	•	•
M12 x 1,25	9.000	7.000	11.40	100.000	20.000	40.000	12.006	•	•	•
M12 x 1,5	9.000	7.000	11.30	100.000	20.000	40.000	12.007	•	•	•
M14 x 1,25	11.000	9.000	13.40	100.000	20.000	40.000	14.006	•	•	•
M14 x 1,5	11.000	9.000	13.30	100.000	20.000	40.000	14.007	•	•	•
M16 x 1,5	12.000	9.000	15.30	100.000	22.000	44.000	16.007	•	•	•
M20 x 1,5	16.000	12.000	19.30	125.000	25.000	44.000	20.007	•	•	•



Oil feed fluteless taps f. ISO metric fine threads



P	•
M	•
K	•
N	○
S	•
H	

Tool material	HSS-E-PM
Tolerance on Ø	6HX
Surface	C
Type	N
Form	E
Internal cooling	

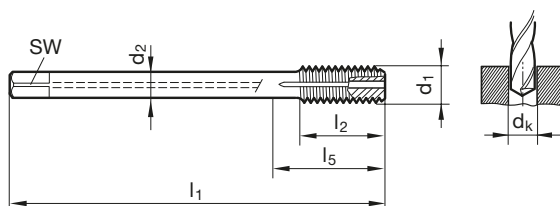

DIN 2174 ~DIN 374

Article no.

4484

Discount group

208

d1	d2	SW	dk	l1	l2	l5	Code no.	Availability
	mm	mm	mm	mm	mm	mm		
M8 x 1	6.000	4.900	7.55	90.000	11.000	35.000	8.005	•
M10 x 1	7.000	5.500	9.55	90.000	11.000	35.000	10.005	•
M10 x 1,25	7.000	5.500	9.40	100.000	14.000	39.000	10.006	•
M12 x 1,25	9.000	7.000	11.40	100.000	16.000	40.000	12.006	•
M12 x 1,5	9.000	7.000	11.30	100.000	16.000	40.000	12.007	•
M14 x 1,25	11.000	9.000	13.40	100.000	15.000	40.000	14.006	•
M14 x 1,5	11.000	9.000	13.30	100.000	15.000	40.000	14.007	•
M16 x 1,5	12.000	9.000	15.30	100.000	15.000	44.000	16.007	•
M20 x 1,5	16.000	12.000	19.30	125.000	16.000	44.000	20.007	•

Oil feed fluteless taps f. ISO metric fine threads



P	•
M	•
K	•
N	○
S	•
H	

Tool material	HSS-E-PM
Tolerance on Ø	6HX
Surface	C
Type	N
Form	C
Internal cooling	

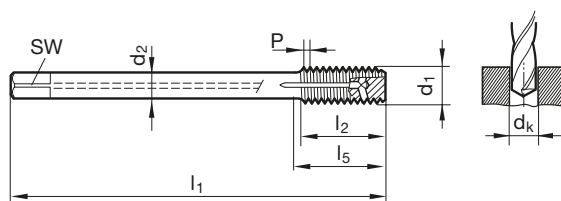

DIN 2174 ~DIN 374

Article no.

4486

Discount group

208

d1	d2	SW	dk	l1	l2	l5	Code no.	Availability
	mm	mm	mm	mm	mm	mm		
M8 x 1	6.000	4.900	7.55	90.000	11.000	35.000	8.005	•
M10 x 1	7.000	5.500	9.55	90.000	11.000	35.000	10.005	•
M10 x 1,25	7.000	5.500	9.40	100.000	14.000	39.000	10.006	•
M12 x 1,25	9.000	7.000	11.40	100.000	16.000	40.000	12.006	•
M12 x 1,5	9.000	7.000	11.30	100.000	16.000	40.000	12.007	•
M14 x 1,25	11.000	9.000	13.40	100.000	15.000	40.000	14.006	•
M14 x 1,5	11.000	9.000	13.30	100.000	15.000	40.000	14.007	•
M16 x 1,5	12.000	9.000	15.30	100.000	15.000	44.000	16.007	•
M20 x 1,5	16.000	12.000	19.30	125.000	16.000	44.000	20.007	•



Fluteless machine taps for UNC-threads



P	•
M	•
K	•
N	○
S	•
H	

Tool material	HSS-E-PM
Tolerance on Ø	2BX
Surface	C
Type	N
Form	C
Internal cooling	

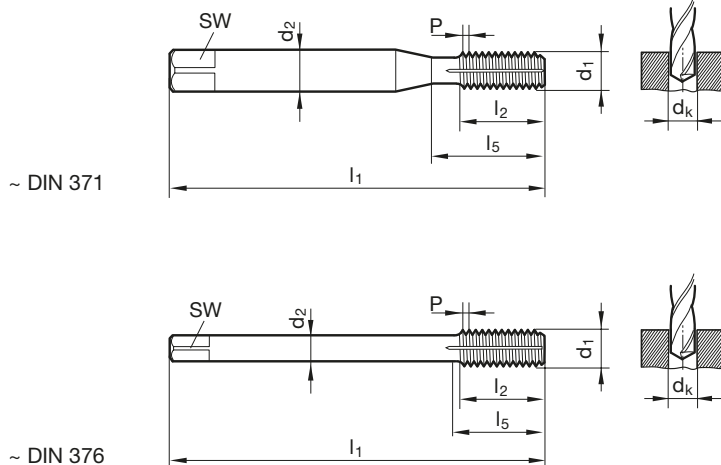

DIN 2184-1 ~DIN 371/~DIN 376

Article no. **4491**

Discount group **208**

d1	d2	SW	dk	l1	l2	l5	Code no.	Availability
	mm	mm	mm	mm	mm	mm		
4 - 40	3.500	2.700	2.55	56.000	11.000	18.000	2.845	•
6 - 32	4.000	3.000	3.15	56.000	12.000	20.000	3.505	•
8 - 32	4.500	3.400	3.80	63.000	12.000	21.000	4.166	•
10 - 24	6.000	4.900	4.35	70.000	14.000	25.000	4.826	•
12 - 24	6.000	4.900	5.00	80.000	16.000	30.000	5.486	•
1/4 - 20	7.000	5.500	5.75	80.000	16.000	30.000	6.350	•
5/16 - 18	8.000	6.200	7.30	90.000	18.000	35.000	7.938	•
3/8 - 16	10.000	8.000	8.80	90.000	20.000	35.000	9.525	•
7/16 - 14	8.000	6.200	10.30	100.000	22.000	42.000	11.113	•
1/2 - 13	9.000	7.000	11.80	100.000	25.000	40.000	12.700	•
9/16 - 12	11.000	9.000	13.30	100.000	28.000	40.000	14.288	•
5/8 - 11	12.000	9.000	14.80	100.000	30.000	44.000	15.875	•
3/4 - 10	14.000	11.000	17.90	110.000	33.000	44.000	19.050	•

Fluteless machine taps for UNF-threads



P	•
M	•
K	•
N	○
S	•
H	

Tool material	HSS-E-PM
Tolerance on Ø	2BX
Surface	C
Type	N
Form	C
Internal cooling	

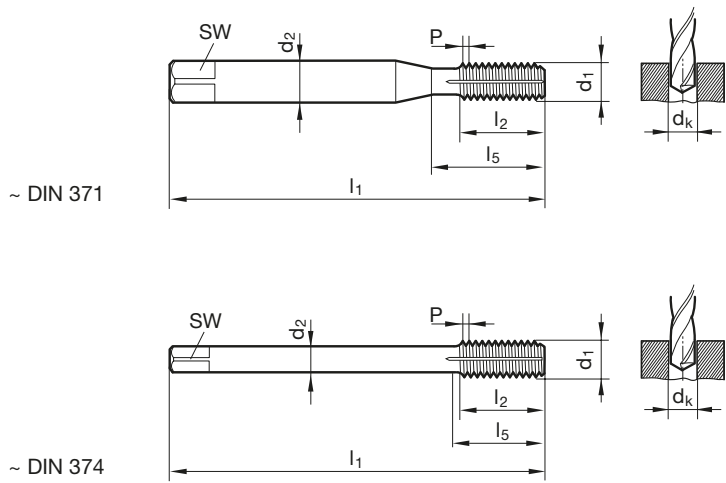

DIN 2184-1 ~DIN 371/~DIN 374 Article no. 4492

Discount group 208

d1	d2	SW	dk	l1	l2	l5	Code no.	Availability
	mm	mm	mm	mm	mm	mm		
4 - 48	3.500	2.700	2.60	56.000	10.000	18.000	2.845	•
6 - 40	4.000	3.000	3.20	56.000	11.000	20.000	3.505	•
8 - 36	4.500	3.400	3.85	63.000	12.000	21.000	4.166	•
10 - 32	6.000	4.900	4.45	70.000	14.000	25.000	4.826	•
12 - 28	6.000	4.900	5.10	80.000	16.000	30.000	5.486	•
1/4 - 28	7.000	5.500	5.95	80.000	16.000	30.000	6.350	•
5/16 - 24	8.000	6.200	7.45	90.000	18.000	35.000	7.938	•
3/8 - 24	10.000	8.000	9.05	100.000	18.000	39.000	9.525	•
7/16 - 20	8.000	6.200	10.55	100.000	22.000	42.000	11.113	•
1/2 - 20	9.000	7.000	12.10	100.000	20.000	40.000	12.700	•
9/16 - 18	11.000	9.000	13.65	100.000	22.000	40.000	14.288	•
5/8 - 18	12.000	9.000	15.25	100.000	22.000	44.000	15.875	•
3/4 - 16	14.000	11.000	18.35	110.000	25.000	44.000	19.050	•



Fluteless machine taps for BSP-threads



P	•
M	•
K	•
N	○
S	•
H	

Tool material	HSS-E-PM
Tolerance on Ø	
Surface	C
Type	N
Form	C
Internal cooling	

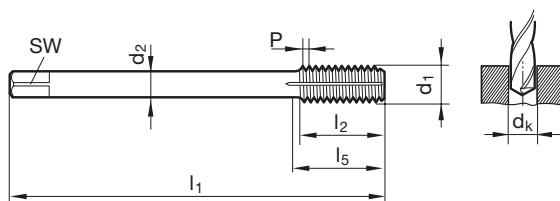

DIN 2184-1 DIN 2189

Article no.

4493

Discount group

208

d1	P	d2	SW	dk	l1	l2	l5	Code no.	Availability
	inch	mm	mm	mm	mm	mm	mm		
G1/8	28.000	7.000	5.500	9.30	90.000	18.000	35.000	9.728	•
G1/4	19.000	11.000	9.000	12.50	100.000	20.000	40.000	13.157	•
G3/8	19.000	12.000	9.000	16.00	100.000	22.000	44.000	16.662	•
G1/2	14.000	16.000	12.000	20.00	125.000	25.000	44.000	20.955	•



CNC Gühro ThreadMill

Free programming software
for thread milling cutters and drill thread milling cutter

In order to make the machining with Gühring thread milling cutters even more user friendly, we have developed the intuitive "CNC Gühro ThreadMill".

"CNC Gühro Thread Mill" is available free-of-charge.
Simply download it from our homepage www.guehring.de.

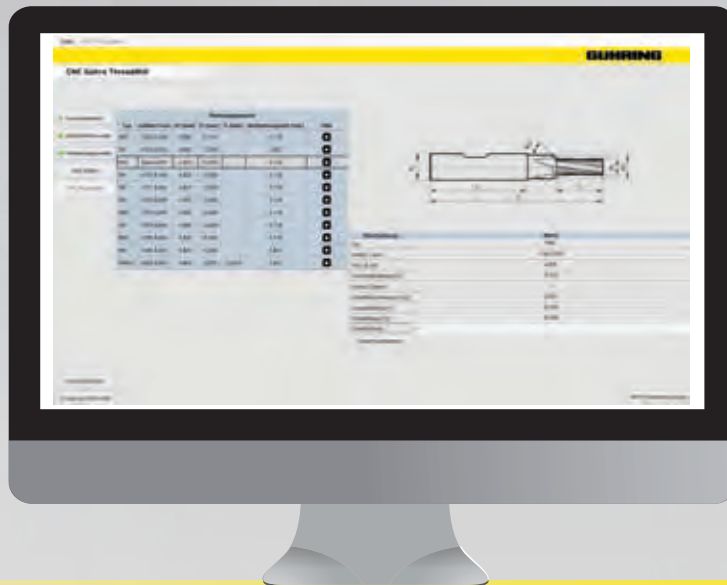

To the optimal CNC programme in five steps

1. Specify the thread data
select from all current thread standards
2. Select the material
you are always referred to the optimal parameters
3. Select the tool
technical data, drawing, machining time and video simplify selection
4. Record CNC data
enter required milling strategy and parameters
5. Receive CNC programme with code and data sheet
programming data (Sinumerik, Haidenhain, Fancu, Philips, Mazatrol or Hurco) are imported and automatically recognised

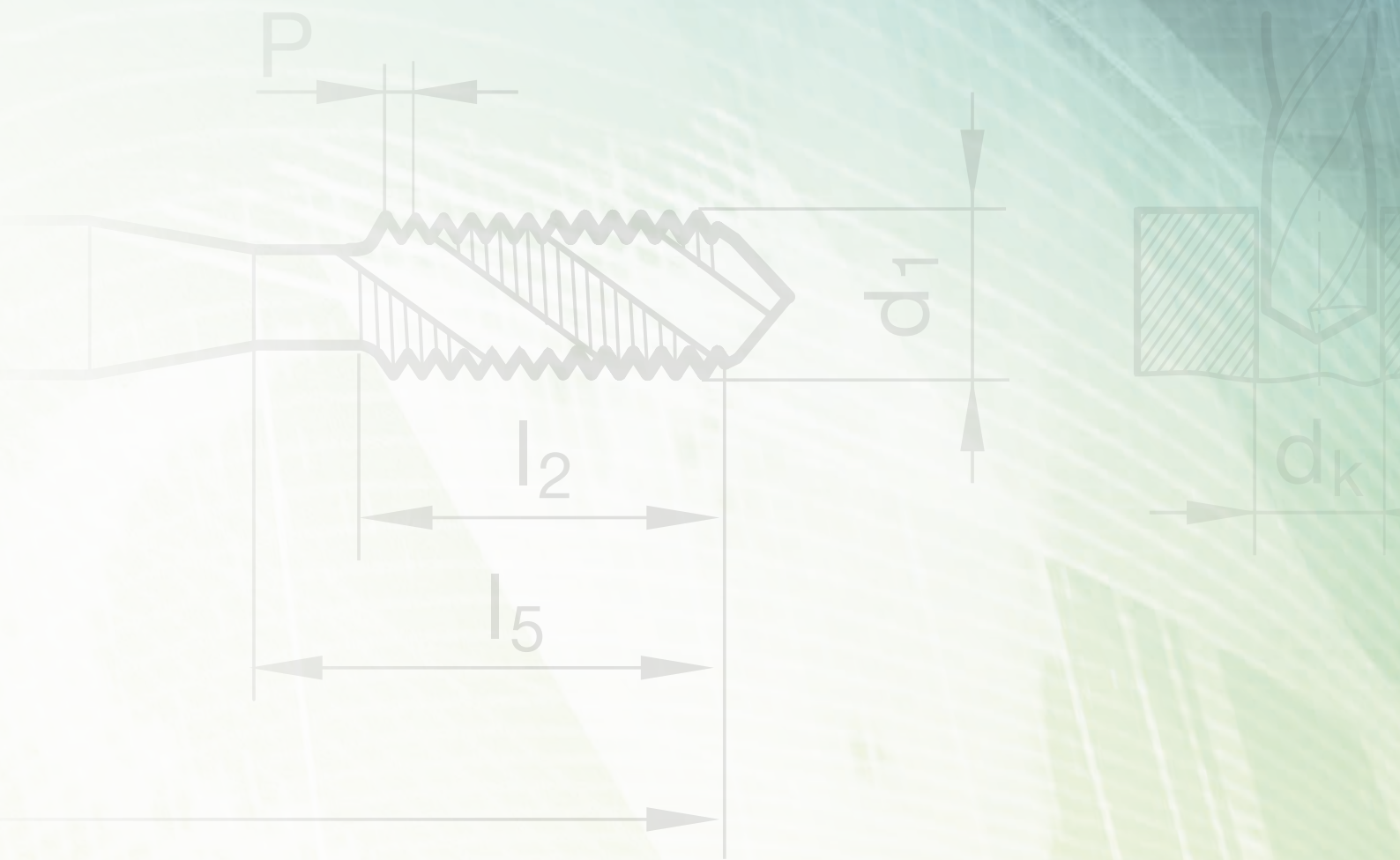

TECHNICAL SECTION



	from page
Tapping size hole and hole diameter	47
DIN characteristic features	50
Comparison of standards	53
The characteristics of different thread types	54
General information for tapping	56
Definitions and angles, centres and flute forms	56
Chamfer forms, selection and application	57
Tolerance fields	59
Taps for ISO metric threads DIN EN 22857 (extract)	60
General information for thread forming	61
Thread production by pressure deformation	61
“Profile“ – Gühring’s new fluteless tap generation	62
Definitions, angles, centres, thread tolerances and fits	63
Tapping size hole diameter	64
Lubrication for thread forming	65



Tapping size holes for thread cutting and thread milling

Std. ISO metric threads DIN 13				ISO metric fine threads DIN 13				UNC threads ASME B1.1							
nom. Ø	pitch P	tapping size hole Ø DIN 336 mm	core diameter of int. thread 6H*	nom. x Ø	pitch P	tapping size hole Ø DIN 336 mm	core diameter of int. thread 6H	nom. x Ø	pitch P	tapping size hole Ø DIN 336 mm	core diameter of int. thread 6H	nom. Ø	threads	tapping size hole Ø DIN 336 mm	core diameter of int. thread 2B
	mm	mm	min. mm max. mm		mm	mm	min. mm max. mm		mm	mm	min. mm max. mm		per inch	mm	min. mm max. mm
M 1	0.25	0.75	0.729 0.785	M 2.5 x 0.35	2.15	2.121 2.221	M 22 x 1.50	20.50	20.376 20.676	No. 1 - 64	1.55	1.425 1.580			
M 1.1	0.25	0.85	0.829 0.885	M 3.0 x 0.35	2.65	2.621 2.721	M 22 x 2.00	20.00	19.835 20.210	No. 2 - 56	1.85	1.694 1.872			
M 1.2	0.25	0.95	0.929 0.985	M 3.5 x 0.35	3.15	3.121 3.221	M 24 x 1.00	23.00	22.917 23.153	No. 3 - 48	2.10	1.941 2.146			
M 1.4	0.30	1.10	1.075 1.142	M 4.0 x 0.50	3.50	3.459 3.599	M 24 x 1.50	22.50	22.376 22.676	No. 4 - 40	2.35	2.157 2.385			
M 1.6	0.35	1.25	1.221 1.321	M 4.5 x 0.50	4.00	3.959 4.099	M 24 x 2.00	22.00	21.835 22.210	No. 5 - 40	2.65	2.487 2.698			
M 1.8	0.35	1.45	1.421 1.521	M 5.0 x 0.50	4.50	4.459 4.599	M 25 x 1.00	24.00	23.917 24.153	No. 6 - 32	2.85	2.642 2.896			
M 2	0.40	1.60	1.567 1.679	M 5.5 x 0.50	5.00	4.959 5.099	M 25 x 1.50	23.50	23.376 23.676	No. 8 - 32	3.50	3.302 3.531			
M 2.2	0.45	1.75	1.713 1.838	M 6.0 x 0.75	5.20	5.188 5.378	M 25 x 2.00	23.00	22.835 23.210	No. 10 - 24	3.90	3.683 3.937			
M 2.5	0.45	2.05	2.013 2.138	M 7.0 x 0.75	6.20	6.188 6.378	M 27 x 1.00	26.00	25.917 26.153	No. 12 - 24	4.50	4.343 4.597			
M 3	0.50	2.50	2.459 2.599	M 8.0 x 0.50	7.50	7.459 7.599	M 27 x 1.50	25.50	25.376 25.676	1/4 - 20	5.10	4.978 5.258			
M 3.5	0.60	2.90	2.850 3.010	M 8.0 x 0.75	7.20	7.188 7.378	M 27 x 2.00	25.00	24.835 25.210	5/16 - 18	6.60	6.401 6.731			
M 4	0.70	3.30	3.242 3.422	M 8.0 x 1.00	7.00	6.917 7.153	M 28 x 1.00	27.00	26.917 27.153	3/8 - 16	8.00	7.798 8.153			
M 4.5	0.75	3.70	3.688 3.878	M 9.0 x 0.75	8.20	8.188 8.378	M 28 x 1.50	26.50	26.376 26.676	7/16 - 14	9.40	9.144 9.550			
M 5	0.80	4.20	4.134 4.334	M 9.0 x 1.00	8.00	7.917 8.153	M 28 x 2.00	26.00	25.835 26.210	1/2 - 13	10.80	10.592 11.024			
M 6	1.00	5.00	4.917 5.153	M 10 x 0.75	9.20	9.188 9.378	M 30 x 1.00	29.00	28.917 29.153	9/16 - 12	12.20	11.989 12.446			
M 7	1.00	6.00	5.917 6.153	M 10 x 1.00	9.00	8.917 9.153	M 30 x 1.50	28.50	28.376 28.676	5/8 - 11	13.50	13.386 13.868			
M 8	1.25	6.80	6.647 6.912	M 10 x 1.25	8.80	8.647 8.912	M 30 x 2.00	28.00	27.835 28.210	3/4 - 10	16.50	16.307 16.840			
M 9	1.25	7.80	7.647 7.912	M 11 x 0.75	10.20	10.188 10.378	M 30 x 3.00	27.00	26.752 27.252	7/8 - 9	19.50	19.177 19.761			
M 10	1.50	8.50	8.376 8.676	M 11 x 1.00	10.00	9.917 10.153	M 32 x 1.50	30.50	30.376 30.676	1 - 8	22.25	21.971 22.606			
M 11	1.50	9.50	9.376 9.676	M 12 x 1.00	11.00	10.917 11.153	M 32 x 2.00	30.00	29.835 30.210	1 1/8 - 7	25.00	24.638 25.349			
M 12	1.75	10.20	10.106 10.441	M 12 x 1.25	10.80	10.647 10.912	M 33 x 1.50	31.50	31.376 31.676	1 1/4 - 7	28.00	27.813 28.524			
M 14	2.00	12.00	11.835 12.210	M 12 x 1.50	10.50	10.376 10.676	M 33 x 2.00	31.00	30.835 31.210	1 3/8 - 6	30.75	30.353 31.115			
M 16	2.00	14.00	13.835 14.210	M 14 x 1.00	13.00	12.917 13.153	M 33 x 3.00	30.00	29.752 30.252	1 1/2 - 6	34.00	33.528 34.290			
M 18	2.50	15.50	15.294 15.744	M 14 x 1.25	12.80	12.647 12.912	M 35 x 1.50	33.50	33.376 33.676	1 3/4 - 5	39.50	38.938 39.802			
M 20	2.50	17.50	17.294 17.744	M 14 x 1.50	12.50	12.376 12.676	M 36 x 1.50	34.50	34.376 34.676	2 - 4.5	45.00	44.679 45.593			
M 22	2.50	19.50	19.294 19.744	M 15 x 1.00	14.00	13.917 14.153									
M 24	3.00	21.00	20.752 21.252	M 15 x 1.50	13.50	13.376 13.676									
M 27	3.00	24.00	23.752 24.252	M 16 x 1.00	15.00	14.917 15.153									
M 30	3.50	26.50	26.211 26.771	M 16 x 1.25	14.80	14.647 14.912									
M 33	3.50	29.50	29.211 29.771	M 16 x 1.50	14.50	14.376 14.676									
M 36	4.00	32.00	31.670 32.270	M 17 x 1.00	16.00	15.917 16.153									
M 39	4.00	35.00	34.670 35.270	M 17 x 1.50	15.50	15.376 15.676									
M 42	4.50	37.50	37.129 37.799	M 18 x 1.00	17.00	16.917 17.153									
M 45	4.50	40.50	40.129 40.799	M 18 x 1.50	16.50	16.376 16.676									
M 48	5.00	43.00	42.587 43.297	M 20 x 1.00	19.00	18.917 19.153									
M 52	5.00	47.00	46.587 47.297	M 20 x 1.50	18.50	18.376 18.676									
M 56	5.50	50.50	50.046 50.796	M 20 x 2.00	18.00	17.835 18.210									
				M 22 x 1.00	21.00	20.917 21.153									

* M 1.1 up to M 1.4 tapping size hole of int. thread 5H

MJ threads DIN ISO 5855				UNC threads ISO 3161				UNF threads ISO 3161			
nom. Ø	x pitch P	tapping size hole Ø DIN 336 mm	core diameter of int. thread 5H*	nom. Ø	threads	tapping size hole Ø DIN 336 mm	core diameter of int. thread 3B	nom. Ø	threads	tapping size hole Ø DIN 336 mm	core diameter of int. thread 3B
	mm	mm	min. mm max. mm		per inch	mm	min. mm max. mm		per inch	mm	min. mm max. mm
MJ 3	x 0.50	2.60	2.513 2.653	No. 6 - 32	2.85	2.733 2.939	No. 6 - 40	3.00	2.888 3.053		
MJ 4	x 0.70	3.40	3.318 3.498	No. 8 - 32	3.55	3.393 3.599	No. 8 - 36	3.60	3.480 3.663		
MJ 5	x 0.80	4.30	4.221 4.421	No. 10 - 24	4.00	3.795 4.064	No. 10 - 32	4.20	4.054 4.255		
MJ 6	x 0.50	5.55	5.513 5.625	No. 12 - 24	4.60	4.455 4.704	No. 12 - 28	4.75	4.602 4.816		
MJ 6	x 0.75	5.35	5.269 5.419	1/4 - 20	5.30	5.113 5.387	1/4 - 28	5.60	5.466 5.662		
MJ 6	x 1.00	5.10	5.026 5.216	5/16 - 18	6.75	6.563 6.833	5/16 - 24	7.00	6.906 7.109		
MJ 8	x 0.50	7.55	7.513 7.625	3/8 - 16	8.20	7.978 8.255	3/8 - 24	8.60	8.494 8.679		
MJ 8	x 0.75	7.35	7.269 7.419	7/16 - 14	9.60	9.346 9.639	7/16 - 20	10.00	9.876 10.084		
MJ 8	x 1.00	7.10	7.026 7.216	1/2 - 13	11.00	10.798 11.095	1/2 - 20	11.60	11.463 11.661		
MJ 8	x 1.25	6.90	6.782 6.994	9/16 - 12	12.40	12.228 12.482	9/16 - 18	13.00	12.913 13.122		
MJ 10	x 1.00	9.10	9.026 9.216	5/8 - 11	13.80	13.627 13.904	5/8 - 18	14.60	14.501 14.702		
MJ 10	x 1.25	8.90	8.782 8.994								
MJ 10	x 1.50	8.60	8.539 8.775								
MJ 12	x 1.75	10.40	10.295 10.560								
MJ 16	x 2.00	14.20	14.051 14.351								

* MJ 3x0.50 up to MJ 5x0.80 tapping size hole of int. thread 6H

Tapping size holes for thread cutting and thread milling

UNF threads ASME B1.1					BSW (Whitworth) threads BS84					(Whitworth) threads (DIN-ISO 228-1)					Steel armoured conduit threads to DIN 40430				
nom. Ø	threads per inch	tapping size hole Ø	core diameter of int. thread 2B		nom. Ø	threads per inch	tapping size hole Ø	core diameter of int. thread		nom. Ø	threads per inch	tapping size hole Ø	core diameter of int. thread		nom. Ø	threads per inch	tapping size hole Ø	core diameter of int. thread	
		DIN 336 mm	min. mm	max. mm			DIN 336 mm	min. mm	max. mm			DIN 336 mm	min. mm	max. mm			DIN 336 mm	min. mm	max. mm
No. 1-72		1.55	1.473	1.610	W 1/16	60	1.20	1.045	1.230	G 1/16	28	6.80	6.561	6.843	Pg 7	20	11.40	11.280	11.430
No. 2-64		1.85	1.755	1.910	W 3/32	48	1.80	1.704	1.912	G 1/8	28	8.80	8.566	8.848	Pg 9	18	14.00	13.860	14.010
No. 3-56		2.15	2.024	2.197	W 1/8	40	2.50	2.362	2.591	G 1/4	19	11.80	11.445	11.890	Pg 11	18	17.30	17.260	17.410
No. 4-48		2.40	2.271	2.459	W 5/32	32	3.20	2.952	3.214	G 3/8	19	15.25	14.950	15.395	Pg 13.5	18	19.00	19.060	19.210
No. 5-44		2.70	2.550	2.741	W 3/16	24	3.60	3.407	3.745	G 1/2	14	19.00	18.631	19.172	Pg 16	18	21.30	21.160	21.310
No. 6-40		2.95	2.819	3.023	W 7/32	24	4.50	4.201	4.539	G 5/8	14	21.00	20.587	21.128	Pg 21	16	26.90	26.780	27.030
No. 8-36		3.50	3.404	3.607	W 1/4	20	5.10	4.724	5.156	G 3/4	14	24.50	24.117	24.658	Pg 29	16	35.50	35.480	35.730
No. 10-32		4.10	3.962	4.166	W 5/16	18	6.50	6.130	6.590	G 7/8	14	28.25	27.877	28.418	Pg 36	16	45.50	45.480	45.730
No. 12-28		4.60	4.496	4.724	W 3/8	16	7.90	7.492	7.987	G 1	11	30.75	30.291	30.931	Pg 42	16	52.50	52.480	52.730
1/4 - 28		5.50	5.359	5.588	W 7/16	14	9.20	8.789	9.330	G 1 1/8	11	35.50	34.939	35.579	Pg 48	16	57.80	57.780	58.030
5/16 - 24		6.90	6.782	7.036	W 1/2	12	10.50	9.989	10.591	G 1 1/4	11	39.50	38.952	39.592					
3/8 - 24		8.50	8.382	8.636	W 9/16	12	12.00	11.577	12.179	G 1 1/2	11	45.25	44.845	45.485					
7/16 - 20		9.90	9.728	10.033	W 5/8	11	13.50	12.918	13.558	G 1 3/4	11	51.00	50.788	51.428					
1/2 - 20		11.50	11.328	11.608	W 3/4	10	16.25	15.797	16.483	G 2	11	57.00	56.656	57.296					
9/16 - 18		12.90	12.751	13.081	W 7/8	9	19.25	18.611	19.353										
5/8 - 18		14.50	14.351	14.681	W 1	8	22.00	21.334	22.147										
3/4 - 16		17.50	17.323	17.678	W 1 1/8	7	24.50	23.928	24.832										
7/8 - 14		20.40	20.269	20.650	W 1 1/4	7	27.75	27.103	28.007										
1 - 12		23.25	23.114	23.571	W 1 3/8	6	30.50	29.504	30.528										
1 1/8 - 12		26.50	26.289	26.746	W 1 1/2	6	33.50	32.679	33.703										
1 1/4 - 12		29.50	29.464	29.921	W 1 5/8	5	35.50	34.769	35.963										
1 3/8 - 12		32.75	32.639	33.096	W 1 3/4	5	39.00	37.944	39.138										
1 1/2 - 12		36.00	35.814	36.271	W 2	4.5	44.50	43.571	44.877										

NPT ANSI B 2.1 American tapered pipe thread 1:16

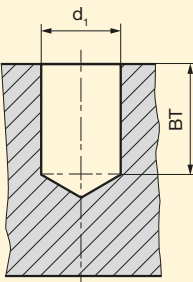
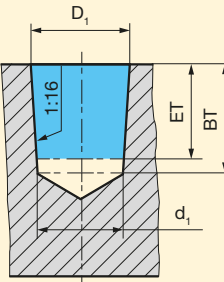
Version A (avoid if possible)		Version B		nom. Ø	threads per inch	tapp. size hole Ø cylindrical (A) d ₁	tapp. size hole Ø conical (B) D ₁	cutting depth ET mm	cutting depth BT (min) mm
				1/16	- 27	6.15	6.39	9.29	10.7
				1/8	- 27	8.40	8.74	9.32	10.8
				1/4	- 18	11.10	11.36	13.52	15.6
				3/8	- 18	14.30	14.80	13.83	16.0
				1/2	- 14	17.90	18.32	18.07	20.8
				3/4	- 14	23.30	23.67	18.55	21.3
				1	- 11.5	29.00	29.69	22.29	25.6
				1 1/4	- 11.5	37.70	38.45	22.80	26.1
				1 1/2	- 11.5	43.70	44.52	22.80	26.1
				2	- 11.5	55.60	56.56	23.20	26.5
				2 1/2	- 8	66.30	67.62	31.75	36.3
				3	- 8	82.30	83.52	33.74	38.5

Metric/metric fine EG-threads (EG M14 x 1.25) for wire thread inserts DIN 8140				
nom. Ø	x pitch P mm	tapping size hole Ø DIN 336 mm	core diameter of int. thread	
			min. mm	max. mm
EG M 4	0.70	4.20	4.152	4.292
EG M 5	0.80	5.25	5.174	5.334
EG M 6	1.00	6.30	6.217	6.407
EG M 8	1.25	8.40	8.271	8.483
EG M10	1.50	10.50	10.324	10.560
EG M12	1.75	12.50	12.379	12.644
EG M14 x 1.25		14.40	14.271	14.483
EG M16	2.00	16.50	16.433	16.733

UNC (UNC-STI) EG-threads for wire thread inserts ASME B18.29.1				
nom. Ø	threads per inch	tapping size hole Ø DIN 336 mm	core diameter of int. thread	
			min. mm	max. mm
EG No. 6 - 32		3.80	3.678	3.879
EG No. 8 - 32		4.40	4.338	4.524
EG No. 10 - 24		5.20	5.055	5.283
EG No. 12 - 24		5.80	5.715	5.944
EG 1/4 - 20		6.70	6.624	6.868
EG 5/16 - 18		8.40	8.242	8.489
EG 3/8 - 16		10.00	9.868	10.127
EG 7/16 - 14		11.60	11.506	11.783
EG 1/2 - 13		13.30	13.122	13.393
EG 9/16 - 12		14.90	14.747	15.032
EG 5/8 - 11		16.50	16.375	16.673

UNF (UNF-STI) EG-threads for wire thread inserts ASME B18.29.1				
nom. Ø	threads per inch	tapping size hole Ø DIN 336 mm	core diameter of int. thread	
			min. mm	max. mm
EG No. 6 - 40		3.70	3.644	3.818
EG No. 8 - 36		4.40	4.321	4.498
EG No. 10 - 32		5.10	4.999	5.184
EG Nr. 12 - 28		5.70	5.682	5.809
EG 1/4 - 28		6.60	6.546	6.721
EG 5/16 - 24		8.25	8.166	8.352
EG 3/8 - 24		9.80	9.754	9.931
EG 7/16 - 20		11.50	11.389	11.585
EG 1/2 - 20		13.10	12.974	13.172
EG 9/16 - 18		14.70	14.592	14.798
EG 5/8 - 18		16.25	16.180	16.386

Characteristic features of the individual standards

DIN 371

in the master standard
DIN 2184-1

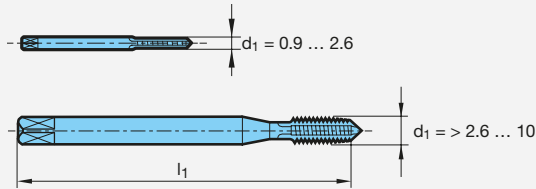

Standard for machine taps with reinforced shank for standard ISO metric threads and ISO metric fine threads. Long design. Shank design in accordance with diameter ranges shown above (mm).

DIN 376

in the master standard
DIN 2184-1

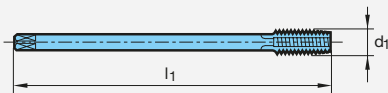

Standard for machine taps with reduced shank for standard ISO metric threads. Long design. Diameter range $d_1 = 1.6 \dots 68$ mm ($\leq \text{Ø M3}$, shank without square)

DIN 374

in the master standard
DIN 2184-1

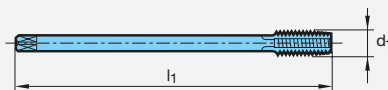

Standard for machine taps with reduced shank for ISO metric fine threads. Long design. Diameter range $d_1 = 3 \dots 52$ mm

DIN 352

in the master standard
DIN 2184-2

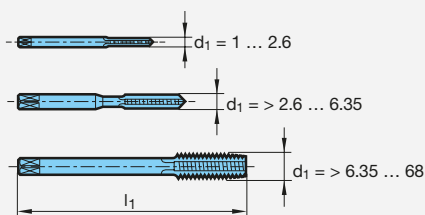

Standard for hand and machine taps for standard ISO metric threads. Short design. Shank design in accordance with diameter ranges shown opposite (mm).



Characteristic of the individual standards

DIN 2181

in the master standard
DIN 2184-2

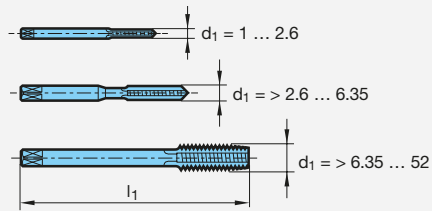

Standard for hand and machine taps for standard ISO metric threads. Short design. Shank design in accordance with diameter ranges shown opposite (mm).

DIN 5156

in the master standard
DIN 2184-1

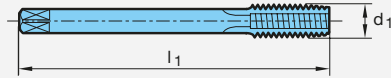

Standard for machine taps for BSP threads to DIN ISO 228 and for BSW threads to DIN 2999. Long design.
Diameter ranges:
BSP threads G 1/16" ... G 4"
BSW threads W 1/16" ... W 4"

DIN 5157

in the master standard
DIN 2184-2

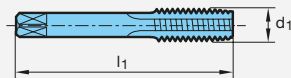

Standard for machine taps for BSP threads to DIN ISO 228 and for BSW threads to DIN EN 10 226-1. Short design.
Diameter ranges:
BSP threads G 1/16" ... G 4"
BSW threads W 1/16" ... W 4"

DIN 40 432

in the master standard
DIN 2184-2

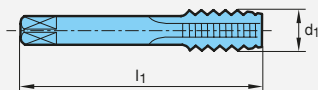

Standard for machine taps for steel armoured conduit threads to DIN 40 430. Short design.
Diameter range:
Pg 7 (12.5 mm) ... Pg 48 (59.3 mm)
Will be replaced by DIN 374 ISO 3 6G.

Characteristic features of the individual standards

DIN 2174

in the master standard
DIN 2184-1

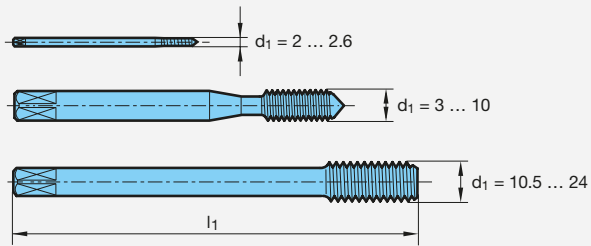

Standard for fluteless taps for standard ISO metric threads and ISO metric fine threads. Long design. Shank design in accordance with diameter ranges shown opposite (mm).

DIN 40 435

in the master standard
DIN 2184-1

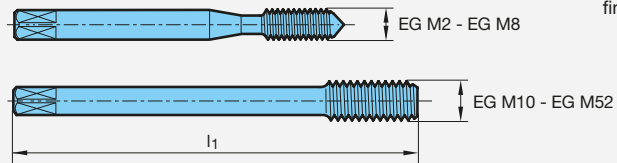

Standard for machine taps for tapped holes (EG) for wire thread inserts as in DIN 8140 for ISO metric threads. Standard thread tapped holes EG M2 to EG M52 and fine thread tapped holes EG M8 x1 to EG M48 x 3



DIN - International Standards

DIN 2184-1
DIN 2184-2

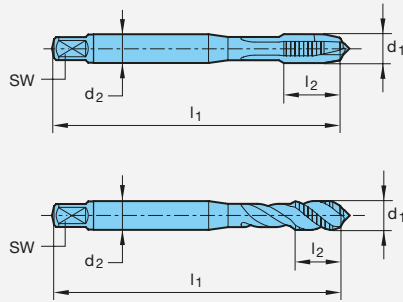

JIS B 4430

Japan Industrial Standard

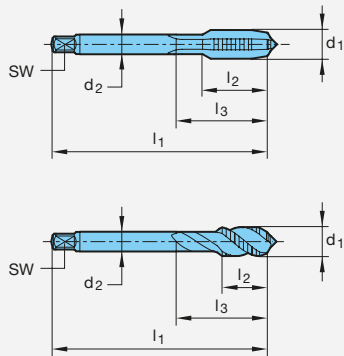

ISO 529

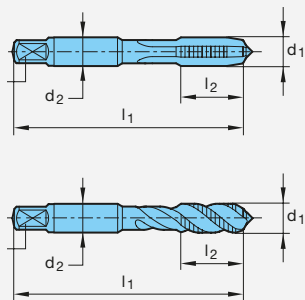

ASME B94.9

The American Society of
Mechanical Engineers

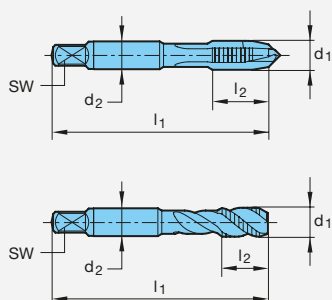

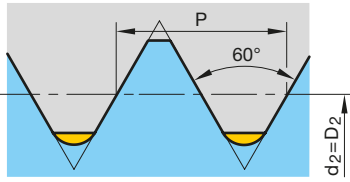
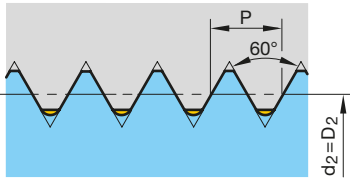
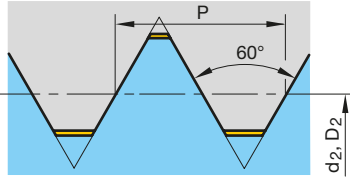
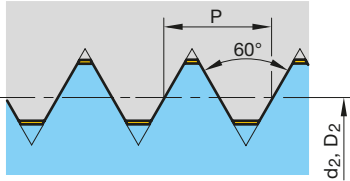
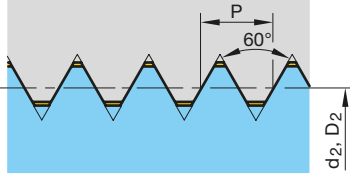
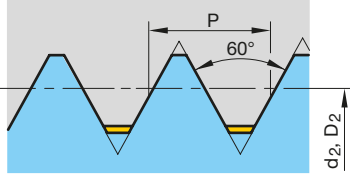
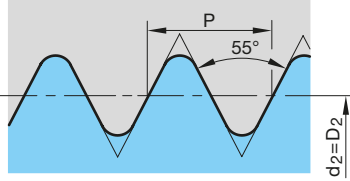
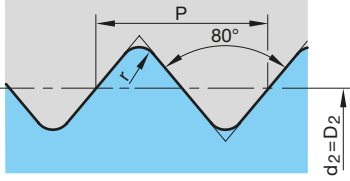
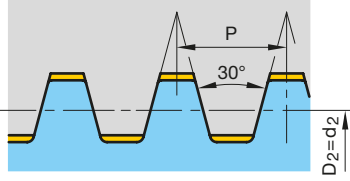
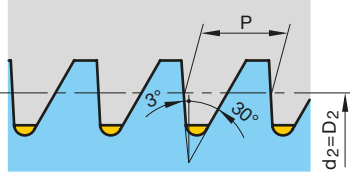
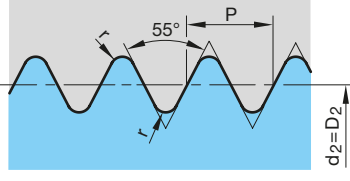
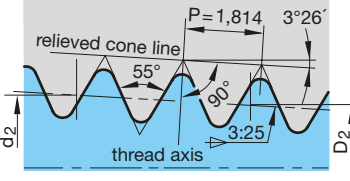
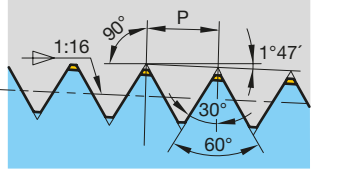
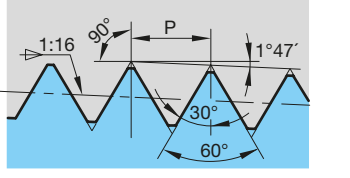
Geometry drawing	Standard	Application	Geometry drawing	Standard	Application
<p>M ISO-metric thread</p> 	DIN 13-1	General standard thread	<p>MF ISO-metric fine thread</p> 	DIN 13-2 to DIN 13-11	General fine thread
<p>UNC Unified National Coarse Thread</p> 	ASME B1.1	General UN standard thread	<p>UNF Unified National Fine Thread</p> 	ASME B1.1	General UN Fine Thread
<p>UNEF Unified National Extra Fine Thread</p> 	ASME B1.1	General UN extra fine thread	<p>UNS Unified Special Thread</p> 	ASME B1.1	General UN special thread
<p>G Cylindrical Pipe Thread without thread sealing connections</p> 	DIN EN ISO 228-1	Threads for pipes, pipe connections and fittings	<p>PG steel conduit thread</p> 	DIN 40430	Electrical engineering
<p>TR ISO-metric trapezoidal thread</p> 	DIN 103	General, draw collets, rolling stock	<p>S metric saw thread</p> 	DIN 513	When absorbing uni-directional forces
<p>W Cylindrical Whitworth Thread</p> 	DIN 477	Side connector and accessories for gas bottle valves	<p>W Whitworth Taper Thread</p> 	DIN 477	Threaded connection in gas cylinder bottles for valves
<p>NPT American Standard Pipe Threads tapered for sealing</p> 	ANSI/ASME B1.20.1	Pipe threads and fittings	<p>NPTF American Standard Pipe Thread tapered for dry sealing</p> 	ANSI B1.20.3	Pipe threads and fittings



Geometry drawing	Standard	Application
<p>BSW cylindrical Whitworth thread</p>	B.S. 84 British Standard	Threads for pipes, pipe connections and fittings
<p>BSP pipe thread cylindrical (identical to G)</p>	B.S. 93 British Standard	Threads for pipes, pipe connections and fittings
<p>R Whitworth pie thread tapered external thread</p>	DIN EN 10226-1 (based on ISO 7-1) replacement for DIN 2999-1	External thread for pipe threads and fittings (for in the thread sealing connections)
<p>Rc Whitworth pipe thread tapered internal thread</p>	DIN ISO 10226-2 (hardly used in Europe, replaceable with pipe threads to ISO 7-1)	Internal thread for pipe threads and fittings (for in the thread sealing connections)
<p>MJ thread metric thread</p>	DIN ISO 5855-1	For the aero- space industry
<p>Vg valve thread</p>	DIN 7756	Valves for car tyres manifold block
<p>MFS</p>	DIN 8141	Interference fits in Aluminium-cast alloys

Geometry drawing	Standard	Application
<p>BSF Whitworth fine thread cylindrical</p>	B.S. 84 British Standard Fine	Threads for pipes, pipe connections and fittings
<p>BSPT pipe thread tapered (identical to Rc)</p>	B.S. 93 British Standard	Internal thread for pipe threads and fittings
<p>Rp Whitworth pipe thread cylindrical internal thread</p>	DIN EN 10226-1 (based on ISO 7-1) Replacement for DIN 2999-1	Internal thread for pipe threads and fittings (for in the thread sealing connections)
<p>RD cylindrical round thread</p>	DIN 405	General, load hook, mining, food industry
<p>UNJ inch thread</p>	ISO 3161	For the aero- space industry
<p>MSG lock nut thread</p>	Gühring standard	Self-locking thread transmission housing etc.

- external thread
- internal thread
- play

Definitions and angles, centres and flute forms

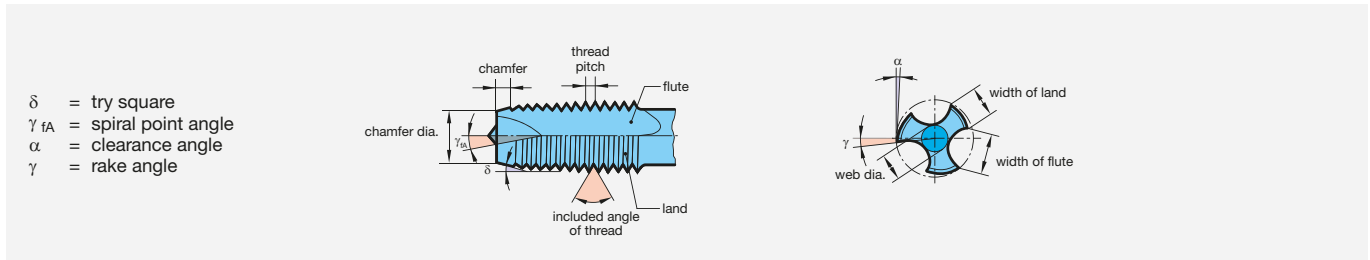
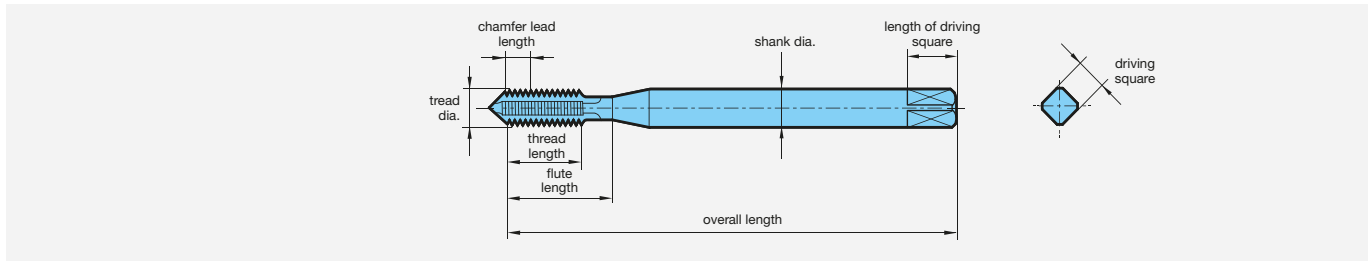

Flute forms

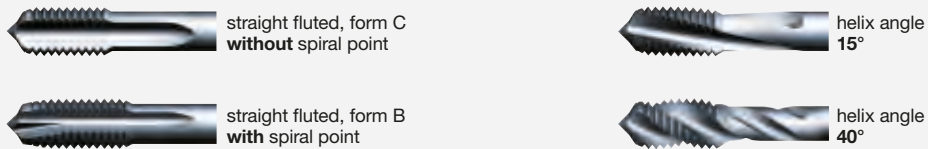

Types of centres (standard, to DIN 2197/DIN 2175)

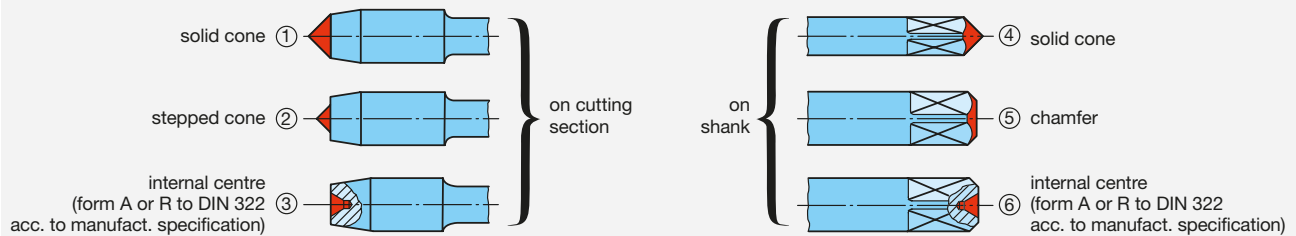

Thread dia. range mm	Centre on cutting section		Centre on shank
	with chamfer forms A, C, D, E	with chamfer form B	
≤ 4.2	①	①	④⑤⑥
> 4.2 ... 5.6	①②	①	④⑤⑥
> 5.6 ... 10.0	①②③	①②③	④⑤⑥
> 10.0	③	③	⑥

Coolant duct geometries





Chamfer forms - Selection and application

When cutting internal threads, all the machining is carried out by the cutting teeth of the chamfer. Therefore, a decision on the best type of chamfer form has to be carefully made as both tool life and quality of thread are thereby greatly affected.

Generally speaking, the form and length of chamfer depend on the type of hole to be tapped. The tapping of through holes does not normally give rise to any difficulties whereas the production of blind holes can create certain problems associated with the need to evacuate swarf in the reverse direction to the feed, i.e. up to the flutes of the tap and then cut off such swarf when the tap is reversed out of the hole.

The length of chamfer is determined by taking into account various conflicting factors. To avoid overloading, premature bluntness and oversize threads the number of chamfer cutting threads must not be kept too low. A too long chamfer lead, however, increases the torque and thus the danger of breakage. The spiral point with form B ensures a chip removal always in the direction of feed.

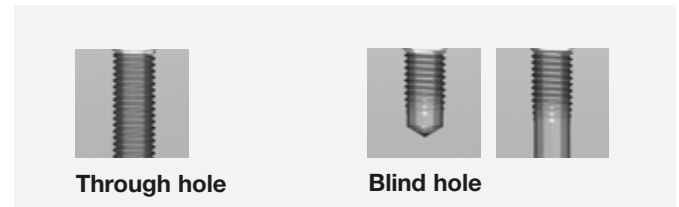

Chamfer forms to DIN 2197

Form A

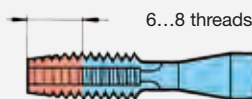

long, 6 - 8 threads
for short
through holes

Form B

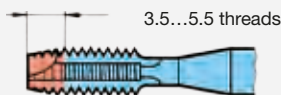

medium, 3.5 - 5.5 threads,
with spiral point,
for all through holes
and deep tapping holes in medium
and long-chipping materials

Form C

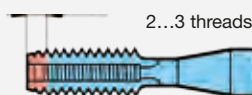

short, 2 - 3 threads
for blind holes
and generally for
aluminium, grey cast iron
and brass

Form D

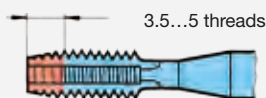

medium, 3.5 - 5 threads
for short
through holes

Form E

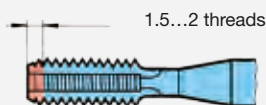

extremely short, 1.5-2 threads,
for blind holes with
little run-out depth.

Form F

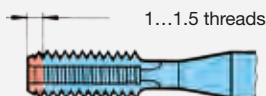

extremely short, 1-1.5 threads,
for blind holes with
little run-out depth.
Avoid use if possible.

Chamfer forms - Selection and application

Chamfer lead length for sets of 3 taps

Form A
first tap

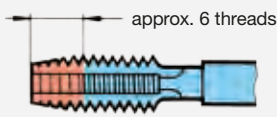

Form D
second tap

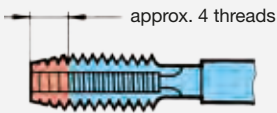

Form C
bottoming tap

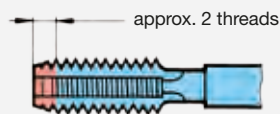

Chamfer lead length for sets of 2 taps

Form D
first tap

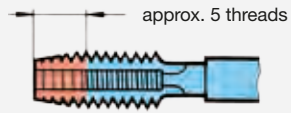

Form C
bottoming tap

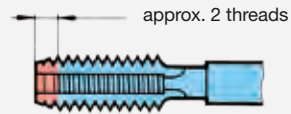

Application recommendations

While in the first instance, the type of tapped hole required determines the chamfer, generally the tap geometry - i.e. form, number and direction of flutes, cutting angle, etc. - depend on the material to be machined and on the application. Basically, taps up to M16 for tapping ISO metric threads or for the engineering industry in general, have 3 flutes, and above this size 4 or more flutes.

Taps with left-hand flutes and taps with spiral points remove the chips in the cutting direction or direction of feed and are therefore especially suitable for tapping through holes. Taps with straight flutes and long chamfer lead (form D) also give good results.

As far as blind holes are concerned we recommend taps with right-hand spiral flutes or straight fluted taps with a short chamfer lead length.

Tools with right-hand spiral flutes have the chip flow in the backward direction, i.e. up the flutes. The chamfer lead length is designed in such a way so that during the return movement chips do not jam and are reliably sheared off.

The tapping of aluminium, grey cast iron and brass requires taps with a short chamfer lead length, regardless of whether through or blind holes are required. In these materials a long chamfer lead length would act as a core drill with chip breaker grooves and would only drill the tapping size hole to the major diameter instead of cutting a thread.

Straight fluted taps without spiral point are general purpose tools and have the disadvantage of not showing optimum results in particular materials. It's well worth the effort to take the trouble of ascertaining the most suitable tool for any given metal-cutting task.



Through hole



Blind hole



Straight fluted tap with spiral point



Right-hand spiral fluted tap



Left-hand spiral fluted tap



Straight fluted tap with short chamfer lead



Straight fluted tap with long chamfer lead



Tolerance fields to DIN EN 22857

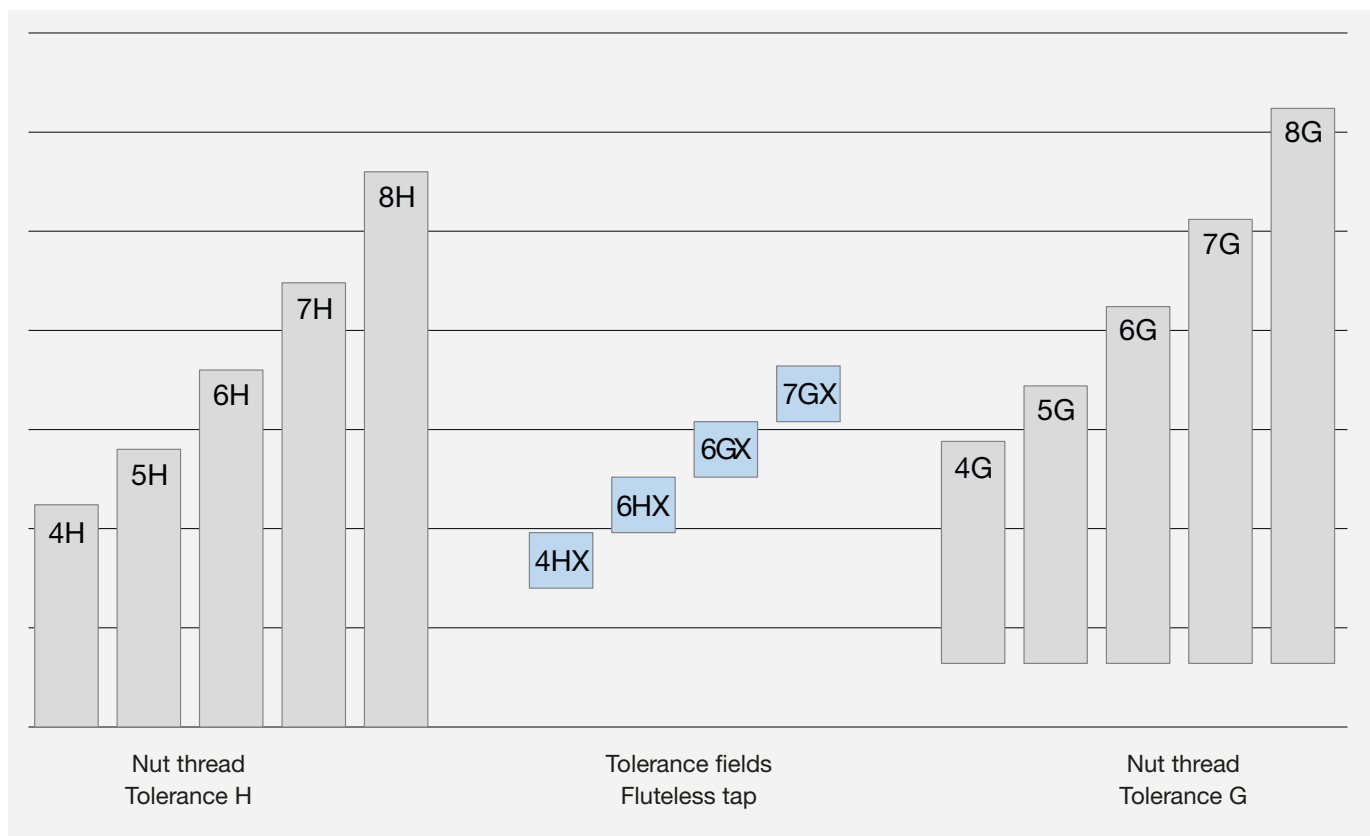
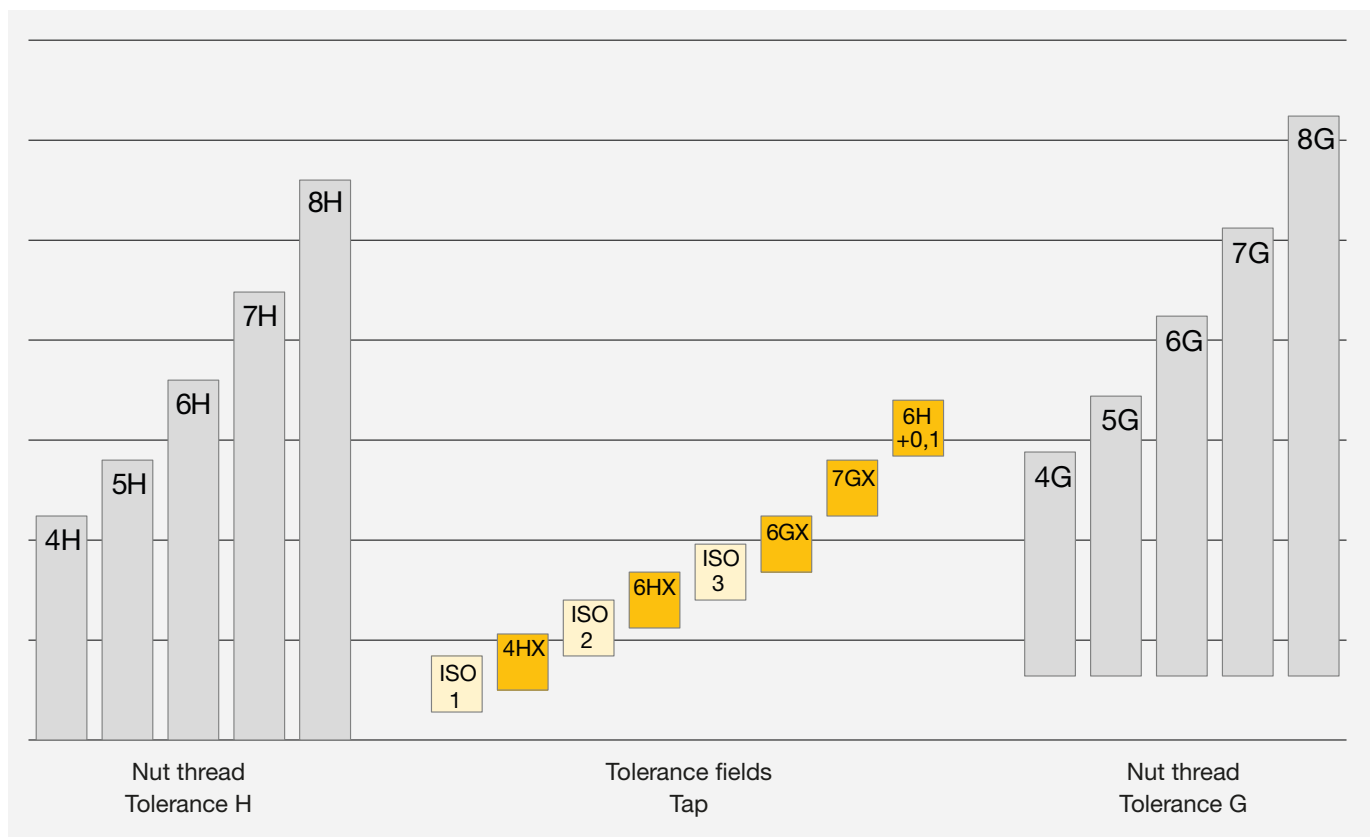

Taps for ISO metric threads DIN EN 22857 (extract)

Thread clearances and fits

Fits between internal and external threads are separated by a diagonal stroke, as for example 6H/6g (internal/external thread). The fit has to be selected in conjunction with the appropriate thread connection.

The tolerance zones of the tolerance classes fine, medium and coarse are allocated to three screw-in lengths short (S), normal (N) and long (L). Generally, the following rules apply for selecting a tolerance class:

Fine tolerance zone (S):

For precision threads, when only a small variation in the fit is permitted.

Medium tolerance zone (N):

General application

Coarse tolerance zone (L):

There are no special precision requirements and in cases where production difficulties may occur, e.g. thread production in hot-rolled rods, deep blind holes or plastic components.

Screw-in lengths

The quality of thread connection is also affected by the screw-in length. The ISO tolerance system was, especially as regards the pitch diameter, divided into three groups, i.e.

- S (Short) = short screw-in length
- N (Normal) = normal screw-in length
- L (Long) = long screw-in length

The following fit should be selected for normal screw-in length N: To ensure a tighter fit of thread connections, we recommend for short screw-in lengths a narrower fit. As far as long screw-in lengths are concerned, fits with a larger tolerance must be used to compensate for pitch deviations.

Thread fits with different flank clearance

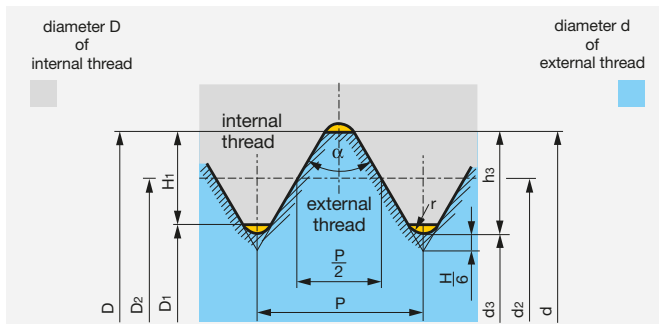

Zero profile of thread fit without flank clearance (H/h-fit).

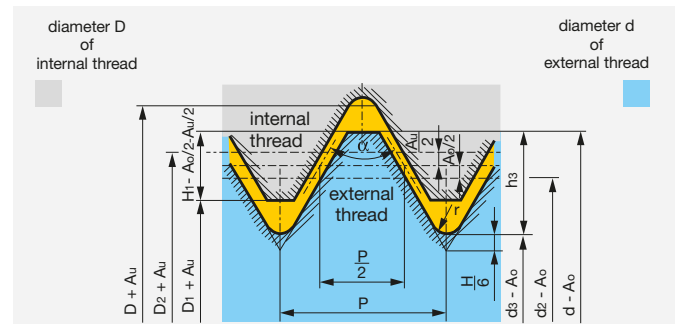

Thread fit with wide flank clearance (G/g-fit or G/e-fit) in external and internal thread.

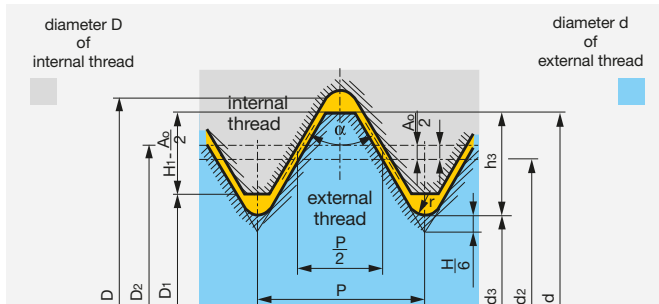

Thread fit with narrow flank (H/g- or H/e-fit) by basic deviation of external thread.

Explanation of symbols

- D = \varnothing nom. of internal thread
- D₁ = Tapping size hole \varnothing of internal thread
- D₂ = Basic pitch \varnothing of internal thread
- d = \varnothing nom. of external thread
- d₂ = Basic pitch \varnothing of external thread
- d₃ = Tapping size hole \varnothing of external thread
- P = Pitch
- α = Included angle of thread
- H = Height of peak to peak thread profile
- A_o = Upper tolerance limit
- A_u = Lower tolerance limit



Thread production by pressure deformation

Fluteless taps are used for the forming of internal threads without chip removal. In contrast to conventional tapping where material is cut from the workpiece, thread forming is a pressure deformation process without chip removal for the production of internal threads. During the process the material is cold formed without interrupting the grain flow.

According to DIN 8583, thread forming is described as “pressing the thread into the workpiece with a tool possessing a spiral working area”. The spiral threaded, polygonal portion of the fluteless tap is “screwed” into the pre-drilled workpiece with an appropriate constant feed rate equal to the thread pitch. Hereby the thread profile is pressed gradually via the forming lead into the material of the workpiece so to speak. Subsequently, the pressure in the deformation zone exceeds the compression limit, the workpiece becomes ductile and is deformed. The material yields radially, “flows” along the thread profile in the unoccupied base of the tool and forms the minor diameter of the nut thread. The flow process creates the process specific form pockets (claws).

The tapping size hole diameter is heavily dependent on the formability of the material, the workpiece geometry and the required effective depth of the thread. In comparison to conventional tapping, a larger diameter tapping size hole should be selected. With a larger diameter tapping size hole the load on the tool is reduced whilst increasing the tool life. Thanks to the uninterrupted grain flow, the loading capacity of the thread remains sufficient with a 50% effective thread depth.

The partially formed crests of the thread with decreasing effective thread depth are a typical characteristic of threads produced by the thread forming process. With the flanks of the thread fully formed, they have no influence on the tensile strength of the thread. If necessary, the required deformation level of the thread should be determined by performing a test.

Lubrication is of significant importance. The lubrication prevents material from building up on the thread flanks and ensures that the necessary torque for the forming process is not too high. Therefore, under no circumstances should there ever be a break-down in lubrication! Preference should be given to lubricants such as cooling agents or oils containing graphite such as those used in rolling processes. Always follow the rule: “The better the lubrication the easier the thread forming process!”

It offers the following advantages

- no chip formation.
- one tool for the production of threads in through and blind holes.
- application in wide range of materials.
- no cutting errors.
- pitch and angle of thread errors that can occur with thread cutting are eliminated.
- internal threads produced by thread forming possess a higher tensile strength particularly at the thread flanks thanks to the so-called “uninterrupted grain flow” and the cold forming process.
- the surface of the thread is improved.
- fluteless taps can be applied at higher speeds because the formability of many materials increases with the forming speed. This does not have a negative effect on the tool life.
- reduced danger of breakage through rigid design

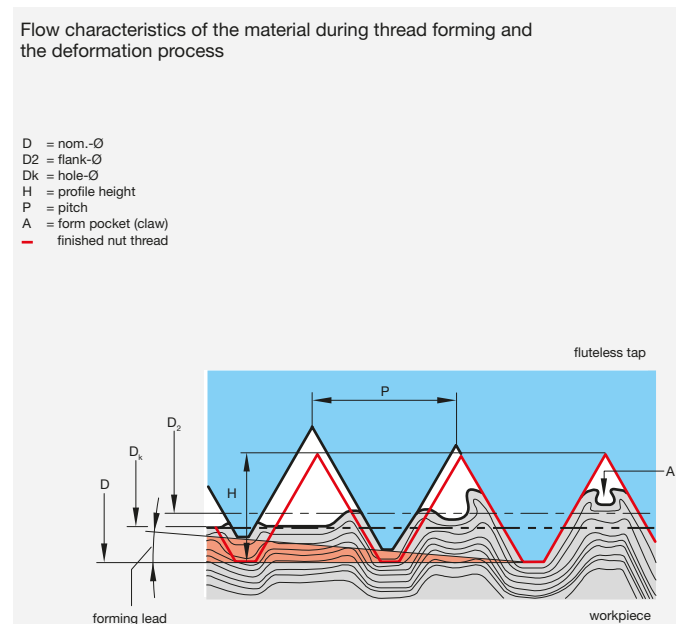
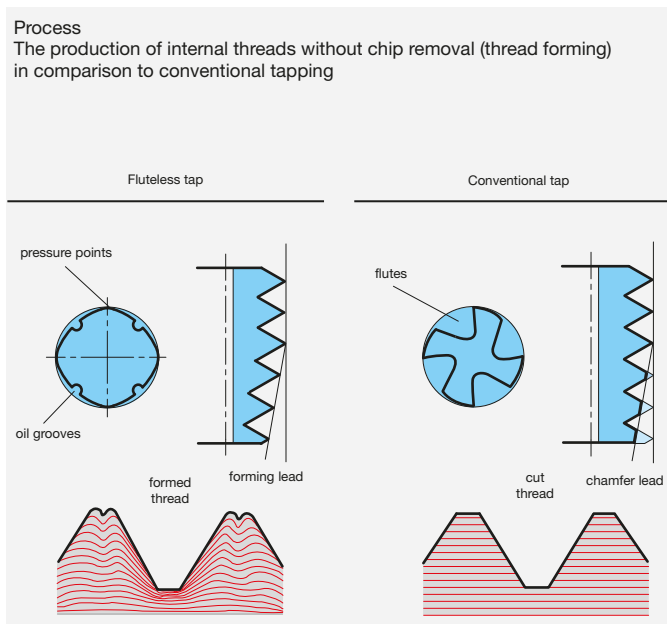

“Profile“ – Gühring’s new fluteless tap generation

Characteristics and advantages

Conventional fluteless taps, produced by a grinding process only, show traces of microscopic, very fine grinding marks on the surface of the tool. This also applies to the threaded portion of the tool required to perform the thread forming operation.

This surface topography (structure) has a negative effect on the friction between the tool and the material to be re-formed as well as on the herewith associated heat development, on the necessary torque and last but not least on the wear of the pressure points of the fluteless tap. In addition, the “grinding marks” encourage the build-up of the material to be re-formed in the thread flanks of the fluteless tap. This is also called cold welding.

Thanks to a special process to improve the surface topography (structure), Gühring’s new Profile fluteless taps no longer possess these “grinding marks”. This has been confirmed in research and tool life studies in varying materials under production conditions.

For the user, a longer tool life and increased cutting speeds are the benefits of this special process. The tool life can be increased considerably depending on the material to be machined and the application conditions. A 100% increase in tool life is not unusual.

The improved surface topography is not only of benefit to tools with bright finish. Particularly coated tools also benefit from the new process. Outer contour and forming lead greatly determine the performance of the fluteless tap. Numerous tests have shown that fluteless taps with optimal pressure point geometry and quantity achieve increased tool life and dimensional accuracy.

Further improvements in quality are achieved when the fluteless tap is produced completely in one setting and with one grinding wheel - set-up with a special roll. Pitch errors between the thread crests and former lead transition area do not occur as with the conventional grinding process.



Surface of a conventional fluteless tap



Optimised surface of a Gühring Profile fluteless tap

Cross section of fluteless tap

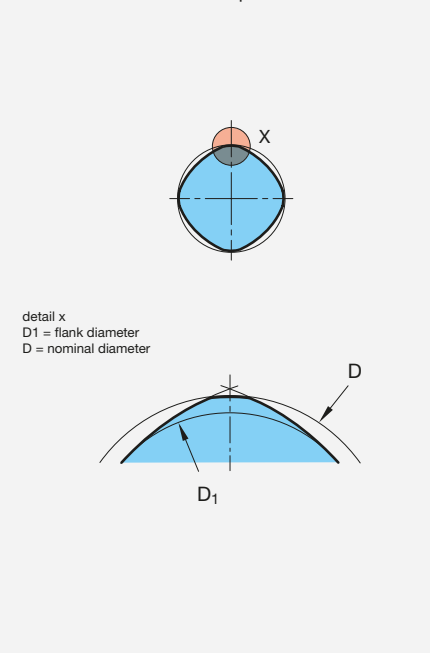

The principle

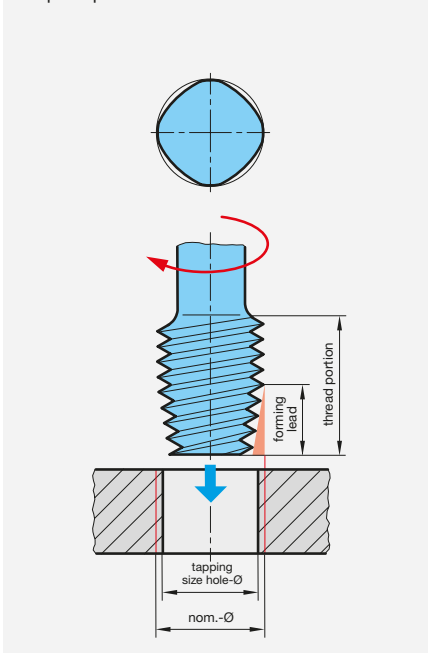

Types of tapping size hole

with fluteless taps without oil grooves
for thread depth $\leq 1 \times D$



for thread depth $\geq 1 \times D$



with fluteless taps with oil grooves
for all thread depths





Definitions, angles, centres, thread tolerances and fits

Thread portion

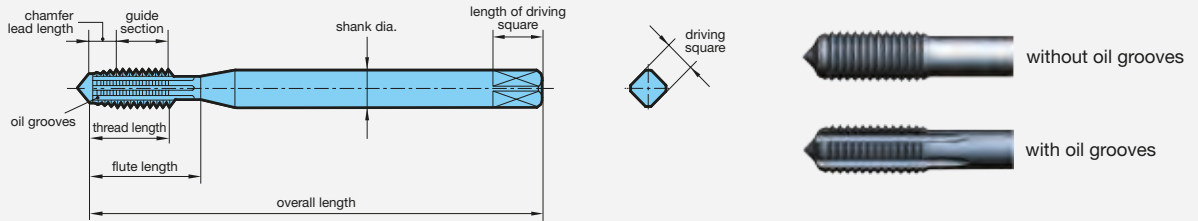

Types of centres (standard, to DIN 2197/DIN 2175)

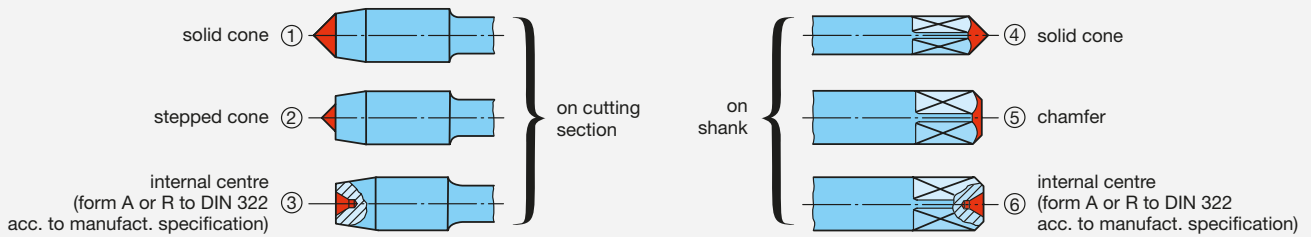

Thread dia. range mm	Centre on cutting section		Centre on shank
	with chamfer forms A, C, D, E	with chamfer form B	
≤ 5.6	①	①	④⑤⑥
> 5.6 ... 12.8	①②③	①②③	④⑤⑥
> 12.8	③	③	⑥

Thread tolerances and fits

Fits between internal and external threads are separated by a diagonal stroke, as for example 6H/6g (internal/external thread). The fit has to be selected in conjunction with the appropriate thread connection.

The tolerance zones of the tolerance classes fine, medium and coarse are allocated to three screw-in lengths short S), normal (N) and long (L). Generally, the following rules apply for selecting a tolerance class:

Fine tolerance zone (S):

For precision threads, when only a small variation in the fit is permitted.

Screw-in lengths

The quality of thread connection is also affected by the screw-in length. The ISO tolerance system was, especially as regards the pitch diameter, divided into three groups, i.e.

- S (Short) = short screw-in length
- N (Normal) = normal screw-in length
- L (Long) = long screw-in length

Medium tolerance zone (N):

General application

Coarse tolerance zone (L):

There are no special precision requirements and in cases where production difficulties may occur, e.g. thread production in hot-rolled rods, deep blind holes or plastic components.

The following fit should be selected for normal screw-in length N: To ensure a tighter fit of thread connections, we recommend for short screw-in lengths a narrower fit.

Tapping size hole diameter

With fluteless tapping, the tapping size hole diameter influences the distinction of the formed thread. A too small tapping size hole diameter results in an over-forming of the thread which must definitely be prevented because this can lead to

tool breakage. A too large tapping size hole is acceptable with certain tolerances because formed threads have a sufficient loading capacity from a 50% bearing depth.

The thread M18x1.5 mm example clearly shows the influence of the tapping size hole diameter selection:

M 18 x 1.00	17.55	17.52	17.62	16.917	17.217
M 18 x 1.50	17.30	17.26	17.38	16.376	16.751
M 18 x 2.00	17.10	17.05	17.20	15.835	16.310

Pre-drilling Ø 17.1 mm



Pre-drilling Ø 17.3 mm



Pre-drilling Ø 17.4 mm



Tapping size hole diameter is too small:

- thread over-formed
- no form pocket (claw)
- profile too high

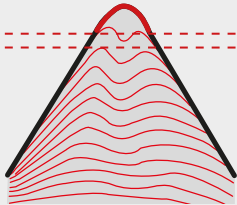

Optimal tapping size hole diameter:

- thread fully formed
- small form pocket (claw)
- optimal height of profile

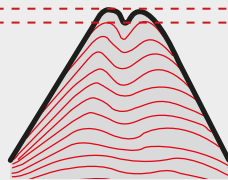

Tapping size hole diameter is too large:

- thread not formed
- large form pocket (claw)
- height of profile too low

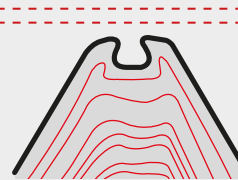

min.
max.

Tapping size hole diameter tolerance zone to DIN 13, part 50

Influence of the tapping size hole on tool life, torque and process reliability

The optimisation of the pre-drilling diameter is especially worthwhile in mass production. The larger it is, the longer the tool life and the less the required torque is. The graphic clearly shows the relationship.

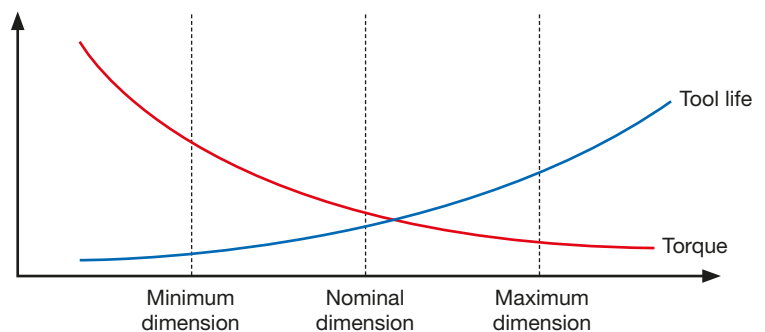



Lubrication for thread forming

For tool design four different cases should be differentiated between.

Vertical machining of a blind hole

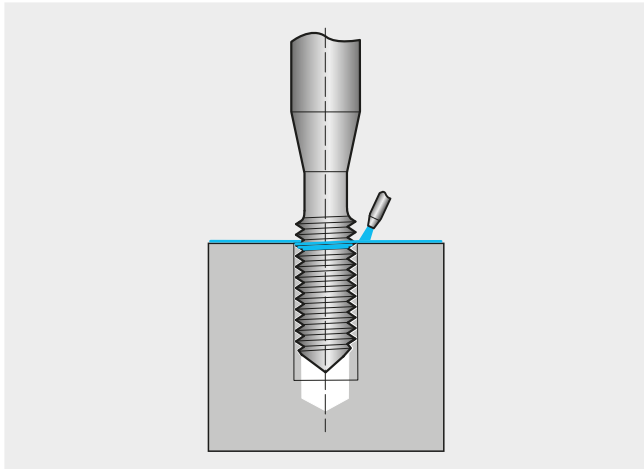

Lubrication grooves and internal coolant delivery is not necessary; external coolant delivery is sufficient (Axial coolant is recommended for very deep threads).

Vertical machining of a through hole (> 1.5xD_N)

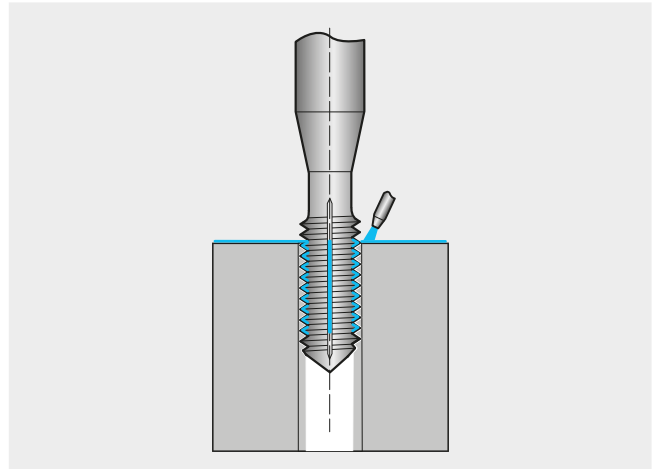

Lubrication grooves are required; internal coolant delivery is not necessary. Via the lubrication grooves the externally delivered coolant can advance to the form edges (Radial coolant is recommended for very deep threads).

Horizontal machining of blind hole

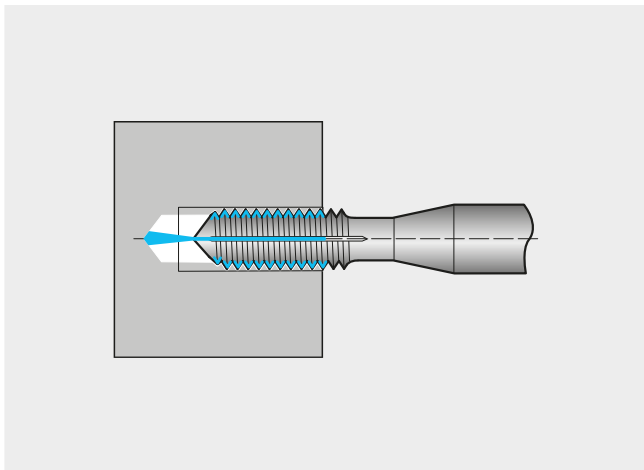

Lubrication grooves and internal coolant delivery is necessary. Axial coolant exit is sufficient.

Horizontal machining of through hole

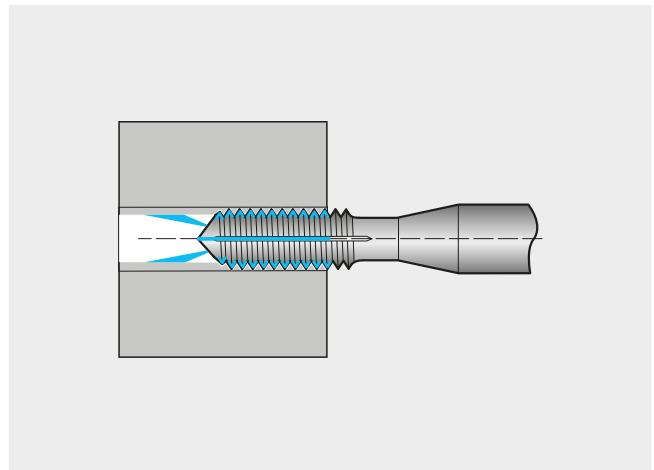

Lubrication grooves are required. Internal coolant delivery with radial exit is recommended.

Cooling lubricants with fluteless taps

With fluteless taps the main task of the coolant is lubrication. The better the lubrication with the maximum concentration, the longer the tool life.

There are two different types of lubricant:

Oil based lubricants

These are mineral oils with the best lubricating characteristics. They reduce friction and achieve optimal life.

Soluble lubricants

These soluble lubricants are a concentrate thinned to an emulsion prior to the use with water. The concentration must not be below 6%. A content more than 12% is ideal in order to achieve a long life thanks to a good lubrication effect.

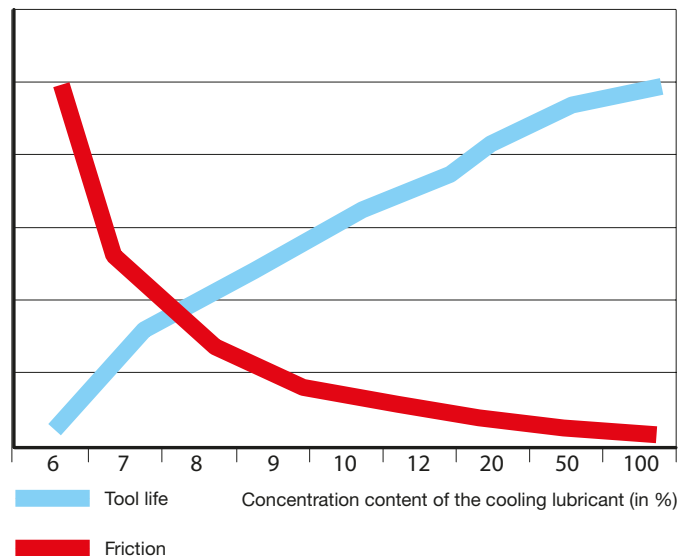

Gühring's tool dispensing systems TM 326, TM 426 and TM 526 optimise your tool storage and your tool management. Gain increased security of your tool stock and increase the transparency of your tool management!



GTMS
Gühring Tool Management Software



GÜHRING



GÜHRING

P.O. Box 100247 • 72423 Albstadt
Herderstrasse 50-54 • 72458 Albstadt

T +49 74 31 17-0
F +49 74 31 17-21279

info@guehring.de
www.guehring.de

No liability can be accepted for printing errors or technical changes of any kind.
Our Conditions of Sale and Terms of Payment apply. Available on request.